

**HVAC/R
Service Products**

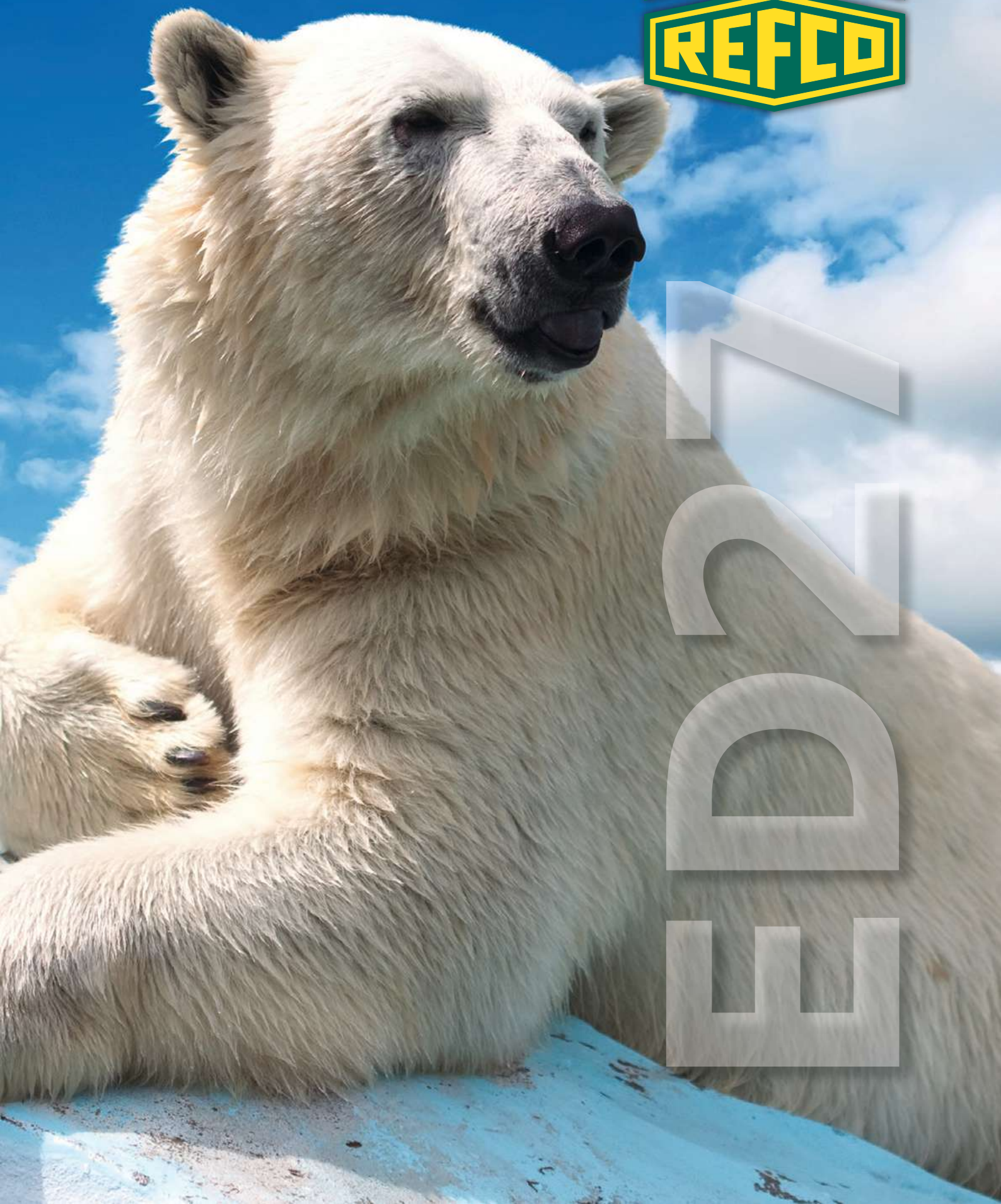

1
2
3
4

特别介绍 - Highlights



LP-88
Page 60



BM2-8-DS-R290
Page 42

新产品可给R290丙烷和R600a异丁烷
New for R290 Propane and R600a Isobutane



ENVIRO-DUO
Page 11

有新的安全供R32和R1234yf
New Safe for R32 and R1234yf



DIGIMON-SE
Page 30



REF-VAC
Page 26



新既紫外线和LED灯
New with both UV- and LED lights

REF-LOCATOR
Page 52



OCTA-WIRELESS
Page 12



HY-EX-6
Page 76

瑞士品质 - Swiss Quality



郑重声明

[威科]公司在此声明目前在市场上已出现[威科]的仿冒品。我们郑重提醒您注意，仿冒产品将不符合[威科]产品的质量标准。如果此类仿冒产品发生故障甚至破裂，[威科]公司将拒绝承担任何责任。

请您与供应商再次确认您获得的是[威科]原厂生产的产品。

Notice to users of REFCO equipment

Unfortunately we had to state an increasing number of copies of REFCO products in the market. We would like to point out to you that these copies do not meet the high quality standard of REFCO products. You therefore take a high risk of injury in case of malfunction or even burst of these copy-products and REFCO refuses any responsibility.

Please ensure with your supplier that you get only original REFCO products.

以上是由DQS瑞士质量及管理系统协会和国际证书网络所颁发的证书，特此证实(威科)制造商所具备的管理系统已达到国际质量管理 and 质量保证标准(ISO 9001)以及国际环境管理质量标准(ISO 14001)。

	真空泵	High-Vacuum Pumps	6 - 9
	冷媒回收机	Recovery stations	10 - 11
	充气计量仪	Electronic Charging Scales	12 - 13
	压力表	Pressure Gauges	14 - 23
	真空表	Vacuum Gauges	24 - 26
	REF-CLASS校准套件	REF-CLASS Calibration kit	27
	电子支管仪	Manifolds	28 - 47
	产品可供R410A及R32	Products for R410A and R32	34 - 39
	充气线	Charging Hoses	48 - 51
	电子泄漏探测器	Electronic Leak Detectors	52 - 55
	紫外线橙漏探测器	UV Leak Detectors	56
	丙烧泄漏探测器	Propane Leak Detectors	57
	温度计, 控制仪器	Thermometers, Control Instruments	58 - 61
	温度控制器	Thermostats	62 - 63
	凝结水泵	Condensate Pumps	64 - 67
	夹取工具	Pinch-off-Tools	68 - 69
	管切割器	Tube Cutters	70 - 71
	燃烧工具	Flaring Tools	72 - 73
	弯管器	Tube Benders	74 - 75
	扩展器工具	Expander Tools	76 - 77
	手工工具	Hand Tools	78 - 79
	自动阀	Auto Valves	80 - 81
	工具与附件	Tools and Accessories	82
	通用继电器	Universal Relay	83
	毛钢管	Capillary Tubes	84 - 85
	插入阀	Access Valves	85 - 87
	技术数据与公司信息	Technical Information	88 - 89

真空泵 - High-Vacuum Pumps

真空泵

由威科专利设计真空泵，均独一无二，根据人体工程学所生产。

标准特征如下：

- 两级阶段旋转式真空泵
- 最新型，极轻巧设计
- 针对冷冻及空调用途
- 独一无二内置式油泵设计
- 体积小，速度快
- 坚固手幻，能有效阻隔运行时所产生的热能
- 特大加泊孔
- 润滑油视镜水平显示
- 配置开关，可作紧急用途
- 连接处有球阀设计，方便操作
- 特别设置泊泵过滤网，减少雾化现象
- 时尚金属，坚固外型，以商品质塑料外壳包装，防止短路主产生危险
- 瑞士商品质产品，生产于 ISO 9001 标准

High-Vacuum Pump

All vacuum pumps are now available in the unique ergonomic REFCO design.

Standard features are:

- Two-stage rotary vane pump
- Latest design and technology allows extremely compact design
- Internal oil pump with unique feature
- High end materials result in low weight top quality
- Sturdy ergonomic handle stays cool to the touch
- Large and easily accessible oil fill port to prevent spillage when filling
- Sight glass for easy viewing of the oil level
- Built in on/off switch to prevent breakage or accidental shut off

- Gas ballast valve
- Easily replaceable one piece cartridge allows exchange without special tooling
- Special designed oil exhaust filter to reduce oil mist
- Modern metal, rugged pump design with high quality plastic housing to absorb shocks
- Extremely low point of gravity which makes tipping over in a service van nearly impossible
- Swiss quality production manufactured under ISO 9001



RL-2

RL-2
最轻巧坚固型

技术数据：

体积： 271x166x195毫米
重量： 3.8公斤
吸气量： 35公升每分钟/
1.25立方尺每分钟
等级： 15微米
马力： 0.16千瓦 (1/4匹) 2400 rpm
电压： 220/240 V, 50/60 Hz
连接口： 1/4" SAE
泊容量： 125毫升
部件号 4661083



RL-4

RL-2
The most compact and lightest in the REFCO range

Technical Data:

Dimensions: 271x166x195 mm
Weight: 3.8 kg
Free air displacement: 35 l/min (1.25 cfm)
Factory micron rating: 15 micron
Motor: 0.16 kW (1/4 HP) / 2400 rpm
Power supply: 220/240 V, 50/60 Hz
Connection: 1/4" SAE
Oil capacity: 125 ml
Part No 4661083



RL-8

RL-4

中级轻巧坚固型

技术数据:

体积: 301x152x204毫米
 重量: 5.65公斤
 吸气量: 65公升/每分钟(2.3立方尺每分钟)
 等级: 15微米
 马力: 0.19千瓦(¼匹)/2400 rpm
 电压: 220/240 V, 50/60 Hz
 连接口: ¼" SAE + ⅜" SAE
 泊容量: 250毫升
 部件号 **4661741**

RL-4

The hard working light weight

Technical Data:

Dimensions: 301x152x204 mm
 Weight: 5.65 kg
 Free air displacement: 65 l/min (2.3 cfm)
 Factory micron rating: 15 micron
 Motor: 0.19 kW (¼ HP) / 2400 rpm
 Power supply: 220/240 V, 50/60 Hz
 Connection: ¼" SAE + ⅜" SAE
 Oil capacity: 250 ml
Part No 4661741

RL-8

重量级坚固型配备组合式球阀

技术数据:

体积: 360x220x250毫米
 重量: 11.8公斤
 吸气量: 150公升/每分钟(5.3立方尺每分钟)
 等级: 15微米
 马力: 0.37千瓦(½匹)/2800 rpm
 电压: 220/240 V, 50/60 Hz
 连接口: ¼" SAE + ⅜" SAE
 组合式球阀
 泊容量: 500毫升
 部件号 **4507348**

RL-8

The one with maximum capacity and integrated ball valve

Technical Data:

Dimensions: 360 x 220 x 250 mm
 Weight: 11.8 kg
 Free air displacement: 150 l/min (5.3 cfm)
 Factory micron rating: 15 micron
 Motor: 0.37 kW (½ HP) / 2800 rpm
 Power supply: 220/240 V, 50/60 Hz
 Connections: ¼" SAE + ⅜" SAE with integrated ball valve
 Oil capacity: 500 ml
Part No 4507348

真空泵 - High-Vacuum Pumps



RL-2-307-RS
 RL-2专用, 1/4" SAE,
 吸入处防止回流接头
 部件号 4663786

RL-4-307-RS
 RL-4专用, 1/4" SAE / 3/8" SAE,
 吸入处防止回流接头
 部件号 4663336

RL-8-307-RS
 RL-8专用, 1/4" SAE / 3/8" SAE,
 吸入处防止回流球阀
 部件号 4664244

RL-2-307-RS
 Intake port 1/4" SAE with backflow prevention
 for RL-2 vacuum pump.
Part No 4663786

RL-4-307-RS
 Intake port 1/4" SAE / 3/8" SAE with
 backflow prevention for RL-4 vacuum pump.
Part No 4663336

RL-8-307-RS
 Intake port 1/4" SAE / 3/8" SAE with ball valve
 and backflow prevention for RL-8 vacuum pump.
Part No 4664244



DV-44/45/46

真空泵用的矿物油 **RL-2/RL-4/RL-8**
Mineral oil for vacuum pumps RL-2/RL-4/RL-8

DV-44	最轻巧坚固型1/4坚固型	Vacuum pump oil 1/4 ltr. bottle	最轻最 / Part 4495340
DV-45	最轻巧坚固型1/2坚固型	Vacuum pump oil 1/2 ltr. bottle	最轻最 / Part 4495358
DV-46	最轻巧坚固型1坚固型	Vacuum pump oil 1 ltr. bottle	最轻最 / Part 4495366
DV-46-Y	最轻巧坚固型1坚固型	Vacuum pump oil 1 ltr. bottle with sealed top	最轻最 / Part 4495323
DV-48	最轻巧坚固型5坚固型	Vacuum pump oil 5 ltr. can	最轻最 / Part 4495331

最轻巧坚固型**RL-2/RL-4/RL-8**
Esteroil for RL-2/RL-4/RL-8

P-17-S-0.25	1/4最轻巧坚固型	1/4 ltr. Esteroil bottle	最轻最 / Part 4503376
P-17-S-1	1最轻巧坚固型	1 ltr. Esteroil bottle	最轻最 / Part 4503384

RD-320

最新的高效能真空泵用于大型专业冷冻、空调和专业操作系统。
这个模型为您提供以下特点：

- 鳍型油箱使其具有更加强大冷却功能
- 冷气机运转时具有超强持续真空状态
- 通用连接器为吸入安装提供更多选择
- 环型全封闭机芯
- 磁性排污格更能吸附金属污染物
- 以1千瓦(1匹)马力的强劲功率快速冷却机器

RD-320

Latest high performance pump for large commercial, air conditioning and specialised operations. This model offers you the following ultimate features:

- Finned oil box for greater cooling capability
- Sustainable ultimate vacuum due to cooler running
- Versatile connections - multiple choice suction fitting

- Fully O-ring sealed cartridge
- Magnetic sump plus aids in capturing ferrous contaminants
- Fan cooled heavy duty 1 hp motor

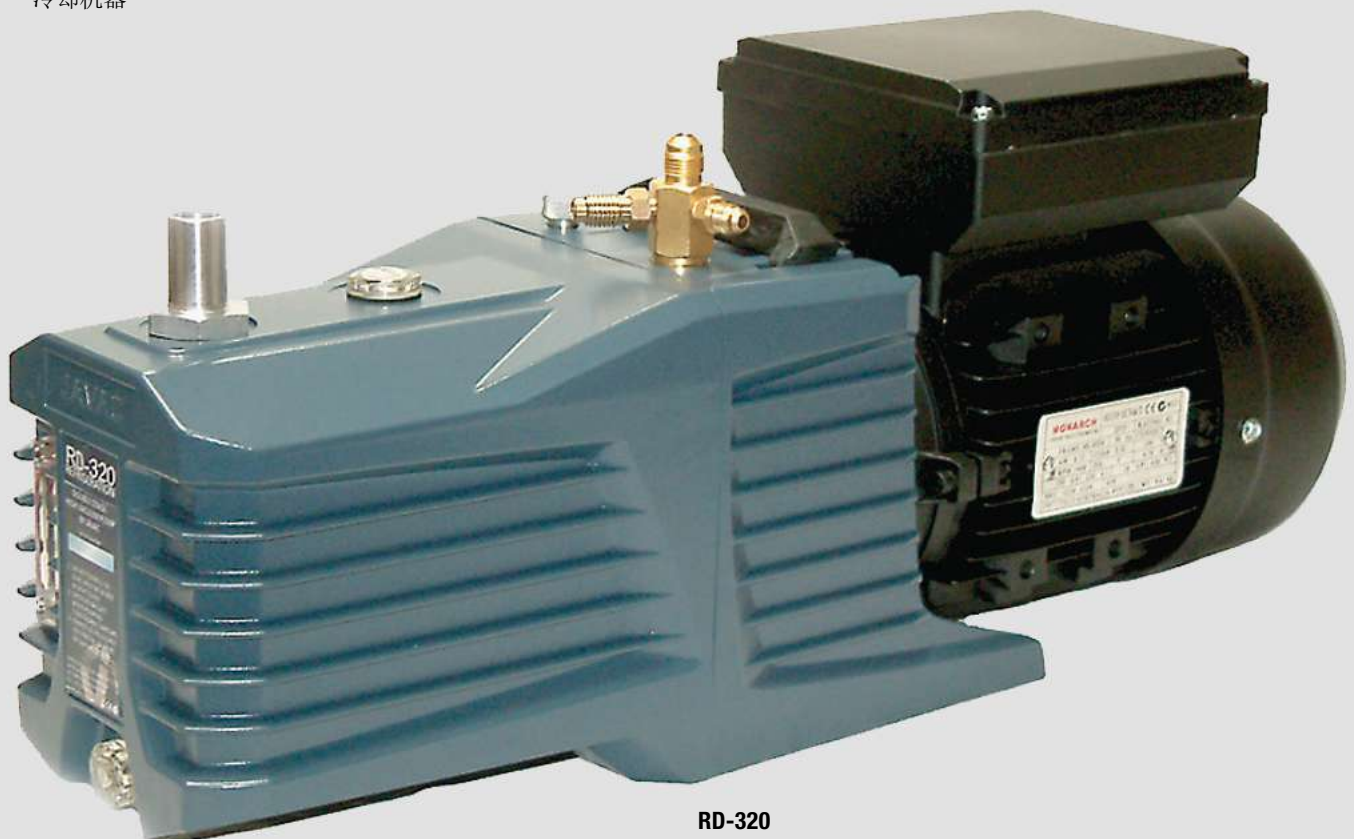

RD-320

技术数据:

体积: 540x160x250毫米
重量: 24.5公斤
吸气量: 300公升f每分钟
(10.5立方只每分钟)
等级: 1微米
马力: 0.75千瓦(1匹)/1400 rpm
电压: 220/240 V, 50/60 Hz
连接口: 3/8" SAE, 1/2" ACME, 1/4" SAE
防护等级: IP 55
部件号 4679373

Technical Data:

Dimension: 540x160x250 mm
Weight: 24.5 kg
Free air displacement: 300 l/min (10.5 cfm)
Factory micron rating: 1 micron
Motor: 0.75 kW (1 HP) / 1400 rpm
Power supply: 220/240 V, 50/60 Hz
Connection: 3/8" SAE, 1/2" ACME, 1/4" SAE
Protection class: IP 55
Part No 4679373

修复站 - Recovery stations

ENVIRO

这是一个单旋钮操作的回收机，风冷式压缩机，充泊歧管容易阅读，保证高效快捷地操作。设计耐用坚固，内置过滤器容易清洗和更换，可于正常操作及运输作出最佳保护作用。



技术数据:

压缩机: ¼ PS/0.55 kW
 电源供应: 220/240伏, 50/60赫斯
 压力表: 充泊
 重量: 14.5公斤
 尺寸: 40x25x34厘米

回收功能:

气体: 可致22公斤/小时
 液体: 可致138公斤/小时
 推动力: 可致378公斤/小时
 部件号 **4686345**

ENVIRO

This state of the art, one-knob operation recovery station allows for recovery of all popular CFC, HCFC and HFC refrigerants including R410A. The oil-less, aircooled compressor assures efficient and fast making irritating oil changes unnecessary. In comparison to other compressors, this unit runs extremely quiet and without vibrations.

Oil-filled manifolds allow for an even easier reading. The compact and ergonomic design as well as the rugged construction provide maximum protection from transport and usage. The ENVIRO is equipped with a self-cleaning mode as well as a built in filter which is easy to clean and replace.



ENVIRO

Technical Data:

Compressor: ¼ PS/0.55 kW, oil-less maintenance free
 Power supply: 220/240 V, 50/60 Hz
 Gauge: Oil-filled
 Weight: 14.5 kg
 Dimensions: 40x35x34 cm

Recovery Rate:

Vapour rate: up to max. 22 kg/h
 Liquid rate: up to max. 138 kg/h
 Push-pull: up to max. 378 kg/h

Part No 4686345

ENVIRO-DUO

这是最先进，高性能的回收机，充泊歧管容易阅读，另外相比接近共同的压缩机在操作过程中噪声电声较低。设计坚固可于正常操作及运输途中作最佳保护作用。ENVIRO-DUO配备80%的溢出保护，以便消洁及更换过滤器。

ENVIRO-DUO

This High performance, state of the art, one-knob operation recovery station allows for maximum recovery of all popular CFC, HCFC and HFC refrigerants including R410A. The oil-less, air-cooled, 2-piston compressor makes an impact due to its impressive performance.

Oilfilled manifolds allow for an even easier reading. Even in close proximity, the noise level during operation is low in comparison to common compressors. The compact and ergonomic design as well as the rugged construction provide maximum protection from transport and usage. The ENVIRO-DUO is equipped with an 80% overfill-protection. Additionally the unit is equipped with a self-cleaning mode as well as a built in filter which is easy to clean and replace.



有新的安全供R32和R1234yf
New Safe for R32 and R1234yf



ENVIRO-DUO

技术数据:

压缩机: 1 PS/0.75 kW
电源供应: 220/240伏, 50/60赫斯
压力表: 充泊
重量: 15.8公斤
尺寸: 40x25x34厘米

Technical Data:

Compressor: 1 PS/0.75 kW, oil-less maintenance free
Power supply: 220/240 V, 50/60 Hz
Gauge: Oil-filled
Weight: 15.8 kg
Dimensions: 40x25x34 cm

回收功率:

气体: 可致33公斤/小时
液体: 可致210公斤/小时
推动力: 可致570公斤/小时
部件号 4686353

Recovery Rate:

Vapour rate: up to max. 33 kg/h
Liquid rate: up to max. 210 kg/h
Push-pull: up to max. 570 kg/h
Part No 4686353

充气计量仪 - Electronic Charging Scales

OCTA-WIRELESS

是可靠的电子冲注冷媒计量器无线传送数据，精确度量冲注重量。计，使10米半径范围内的移动操作的规模。

光，团体，铝外壳随着超薄设计，特别适合用于大型制冷剂钢瓶。

OCTA-WIRELESS 能方便控制面板，可以很容易地进行编程或重新校准。是放置在一个耐用的便携袋内。

技术数据：

最重重量：110公斤(240磅)

面积：直径320毫米

高度45毫米

精精度：+/-0.5%

分辨能力：2克

电力供应：2x4AAA电池

电池寿命：60小时

信号范围：10米

部件号 4686663

OCTA-WIRELESS

This reliable, electronic charging scale transmits the measurement data to the wireless display, allowing for mobile operation of the scale within a radius of 10 m. The light, solid, aluminum housing along with the slim design, makes the OCTA-WIRELESS particularly suitable for large refrigerant cylinders. Through the convenient, wireless control panel, the OCTA-WIRELESS can easily be programmed or recalibrated.

REF-METER-OCTA-PLUS, the automatic charging system, is an ideal addition to the OCTA-WIRELESS. The wireless electronic charging scale is delivered in a durable carrying pouch.

Technical Data:

Capacity: 110 kg (240 lbs)

Platform: diameter 320 mm, height 45 mm

Accuracy: +/-0.5%

Resolution: 2 g

Power supply: 2x4 AAA batteries

Battery lifetime: 60 h control panel + platform

Signal range: 10 m

Part No 4686663



OCTA-WIRELESS



OCTA-WIRELESS-KIT

OCTA-WIRELESS-KIT

组合工具箱包括OCTA-WIRELESS 和 REF-METER-OCTA-PLUS

部件号 4686742



OCTA-WIRELESS-KIT

Combination kit including OCTA-WIRELESS and REF-METER-OCTA-PLUS.

Part No 4686742

REF-METER-OCTA

REF-METER-OCTA是新的艺术设计, 简洁而轻巧, 坚固的铝制外型配备独特的自动电缆卷筒, 它结合国家最先进技术及对充气计量仪REF-METER 的进一步发展的效益而研制成的。REF-METER的优点是高精度和准确性高, 易于读数的液晶显示等。这款高品质的产品为大型制冷缸提供了一个完美的测量平台, 它易于编程和校准。
REF-METER-OCTA 是放置在一个便携袋内。

技术数据:
最重重量: 110公斤(240磅)
面积: 直径320毫米
高度45毫米
精确度: +/-0.5%
分辨能力: 2克
电力供应: 4AAA电池
电池寿命: 30小时
部件号 **4679462**

REF-METER-OCTA

The art design, the lightweight, the sturdy aluminium body as well as the unique cable auto reel combined with state-of-the-art technology are some of the benefits of the further developed REF-METER. The excellent features of REF-METER like the high accuracy, the

easy to read LCD display etc. remain the same. The high quality product offers a perfect platform for large refrigeration cylinders and is easy programmable and calibratable. The REF-METER-OCTA is supplied in a carrying pouch.

Technical Data:

Capacity: 110 kg (240 lbs)
Platform: diameter 320 mm
height 45 mm
Accuracy: +/-0.5%
Resolution: 2 g
Power supply: 4 AAA batteries
Battery lifetime: 30 hours
Part No **4679462**



REF-METER-OCTA



REF-METER-OCTA-PLUS

REF-METER-OCTA-PLUS

自动充电模块可用于REF-METER-OCTA和OCTA-WIRESESS 的高效能和可编程填充制冷剂 and 空调系统。官适用于所有的制冷剂。它会通过视觉和声音信号的提示灌装的重量。

REF-METER-OCTA-PLUS

Automatic charging module available for the REF-METER-OCTA and OCTA-WIRELESS for the efficient and programmable filling of refrigerant and air conditioning systems. It is suitable for all refrigerants. Through a visual and an acoustic signal the achieving of the filling weight is indicated.

技术数据:
充注接口: 1/4" SAE
充电端口: 500磅, 34条
最大阀门工作压力: 4x1.5伏AA碱性电池
电池寿命: >200小时
材料: 阀体黄铜,
氯丁橡胶密封-W
温度: 32 °F至122 °F, 0 °C至50 °C
重量: 1.2磅/0.55公斤
尺寸: 8.6x6.6x1.9英寸
21.5x13.8x4.8毫米

Technical Data:

Charging Port: 1/4" SAE
Max. valve operating pressure: 500 psi, 34 bar
Power supply: 4 x 1.5V AA Alkaline Batteries
Battery lifetime: > 200 hours
Materials: Valve Body Brass, Seal Neoprene-W
Operating temperature: 32 °F to 122 °F
0 °C to 50 °C
Weight: 1.2 lbs/0.55 kg with batteries
Dimensions: 8.6x6.6x1.9 inch
21.5x13.8x4.8 cm

部件号 **4681823**

Part No **4681823**

REF-METER-OCTA-KIT



REF-METER-OCTA-KIT

组合套件包括REF-METER-OCTA和REF-METER-OCTA-PLUS。
部件号 **4681989**

REF-METER-OCTA-KIT

Combination kit including REF-METER-OCTA and REF-METER-OCTA-PLUS.
Part No **4681989**

压力表 - Pressure Gauges

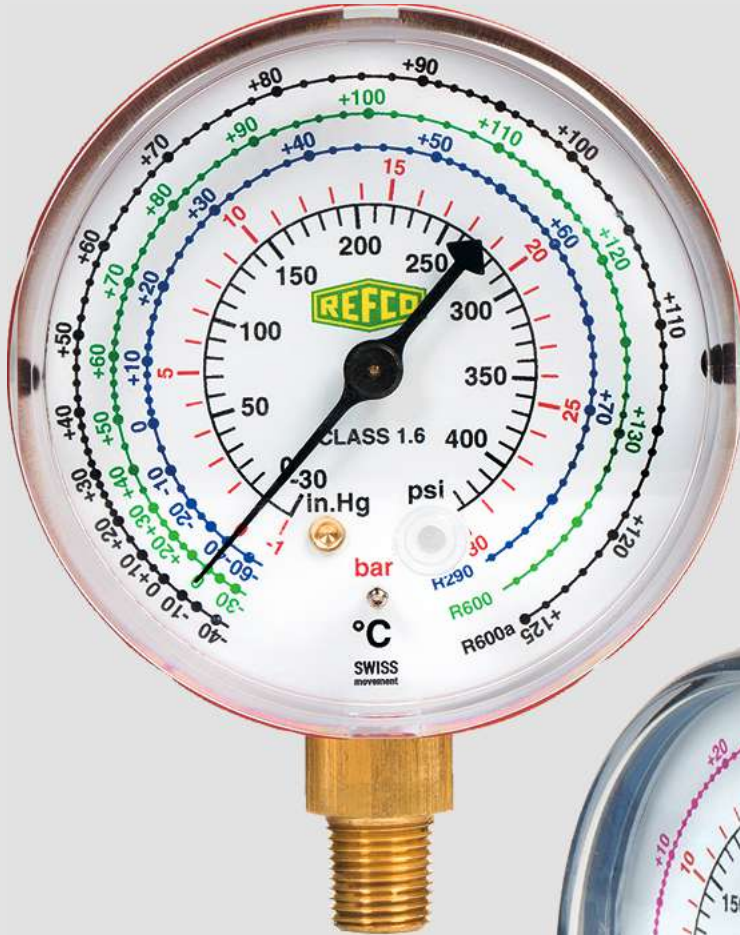

M2-500-DS-R290



M2-255-DS-R410A

SWISS movement

瑞士装嵌
所有的装嵌
都在瑞士:

- 瑞士精密
- 高品质的机械运作
- 可靠
- 准确
- 耐用

Swiss Movement -
All movements are
manufactured
in Switzerland:

- Swiss precision
- High quality of the
motion mechanism
- Reliability
- Accuracy
- Longevity

一般资料

压力计:

M	=	公制、巴
DS	=	双级计量仪巴/每平方英寸
KPA	=	kPa/ 每平方英寸

请在订单上注明您的要求。

温度计:

R12-N	=	R12/R22/R134a
R134a	=	R134a/R404A/R507
R22	=	R22/R134a/R404A
R407C	=	R407C/R134a/R404A
R410A	=	R410A
CLIM	=	R22/R407C/R410A
R32	=	R32/R410A
R1234yf	=	R1234yf/R134a
R744	=	CO2 subcritical state
R290	=	R290/R600/R600a

以上所未列出的制冷计量度计可应要求提供。

压力表的压力范围

巴:	
复合	-1 至 +10 巴
压力	-1 至 +30 巴
公斤/帕斯卡:	
复合	-100 至 +1000 公斤/帕斯卡
压力	-100 至 +3000 公斤/帕斯卡
磅/平方英寸:	
复合	-30 至 +140 磅/平方英寸
压力	-30 至 +400 磅/平方英寸

R410A

巴:	
复合	-1 至 +36 巴
压力	-1 至 +54 巴
公斤/帕斯卡:	
复合	-100 至 +3600 公斤/帕斯卡
压力	-100 至 +5400 公斤/帕斯卡
磅/平方英寸:	
复合	-30 至 +520 磅/平方英寸
压力	-30 至 +780 磅/平方英寸

General information

Pressure scale:

M	=	metric, bar
DS	=	double scale bar/psi
KPa	=	kPa/psi

Please indicate request on your order.

Temperature scale:

R12-N	=	R12/R22/R134a
R134a	=	R134a/R404A/R507
R22	=	R22/R134a/R404A
R407C	=	R407C/R134a/R404A
R410A	=	R410A
CLIM	=	R22/R407C/R410A
R32	=	R32/R410A
R1234yf	=	R1234yf/R134a
R744	=	CO2 subcritical state
R290	=	R290/R600/R600a

Temperature scales for other than the above indicated refrigerants are available on request.

Pressure range of gauges

bar:	
Compound	-1 up to +10 bar
Pressure	-1 up to +30 bar
kPa:	
Compound	-100 up to +1000 kPa
Pressure	-100 up to +3000 kPa
psi:	
Compound	-30 up to +140 psi
Pressure	-30 up to +400 psi

R410A

bar:	
Compound	-1 up to +36 bar
Pressure	-1 up to +54 bar
kPa:	
Compound	-100 up to +3600 kPa
Pressure	-100 up to +5400 kPa
psi:	
Compound	-30 up to +520 psi
Pressure	-30 up to +780 psi

压力表 - Pressure Gauges

SWISS
movement

布顿型计量表 1.6级 - Bourdon Type - Gauge Class 1.6

以下各种类型的计量表外部直径
2 3/4 英寸= 68毫米, 底部连接为
1/8 英寸NPT, 可使用螺丝刀透过
正面玻璃进行调节。

All following types of gaugn with
outside diameter of 2 3/4" = \varnothing 68 mm,
bottom connection 1/8" NPT, adjustable
through the front with a screw driver.

名称 Designation	压力计 Pressure scale		温度计摄氏度 Temperature Scale °C Centigrade										部件号 Part No	
	bar*	psi*	R22	R134a	R404A	R507	R407C	R410A	R32	R1234yf	R290	R600		R600a
M2-250-M-R22-R134a M2-500-M-R22-R134a	● ●		● ●	● ●										9883197 9883198
M2-250-DS-R22 M2-500-DS-R22	● ●	● ●	● ●	● ●	● ●									7462426 7462396
M2-250-DS-R134a M2-500-DS-R134a	● ●	● ●		● ●	● ●	● ●								9389099 9388999
M2-250-DS-R407C M2-500-DS-R407C	● ●	● ●		● ●	● ●		● ●							7105172 7105210
M2-250-DS-SUPER M2-500-DS-SUPER	● ●	● ●												7014732 7015194
M2-255-DS-R410A** M2-555-DS-R410A**	● ●	● ●						● ●						7455896 7456001
M2-250-DS-CLIM** M2-500-DS-CLIM**	● ●	● ●	● ●				● ●	● ●						7245886 7245933
M2-255-DS-R32** M2-555-DS-R32**	● ●	● ●						● ●	● ●					4686901 4686902
M2-250-DS-R1234yf M2-500-DS-R1234yf	● ●	● ●		● ●						● ●				4687044 4687045
M2-250-DS-R290 M2-500-DS-R290	● ●	● ●								● ●	● ●	● ●		4687373 4687374

*bar - 巴 psi - 平方英寸磅

** 低压压力表用于R410A冷煤压力范围为
-1至36巴或-30至520平方英寸磅,
高压压力范围为-1至54巴或
-30至780平方英寸磅。

The lower pressure range on the gauges for
R410A is -1 to 36bar/-30 to 520 psi, the high
pressure range is -1 to 54 bar/-30 to 780 psi.

M2-250-M-R600a

复合表

连接为 $\frac{1}{8}$ NPT, 直径68毫米, 压力显示介子-1至+3巴, 温度计为-30至+30摄氏度.

指针可透过正面视屏的布顿型计量表进行调节, 级别1.6

部件号 **9385882**

M2-250-M-R600a

Compound Gauge

Connection $\frac{1}{8}$ NPT, 68 mm diameter, range -1 to +3 bar for pressure reading, temperature scale -30 to +30 degree

centigrade pointer adjustable via front screen bourdon type gauge, class 1.6

Part No **9385882**

M2-250-DS-R134a

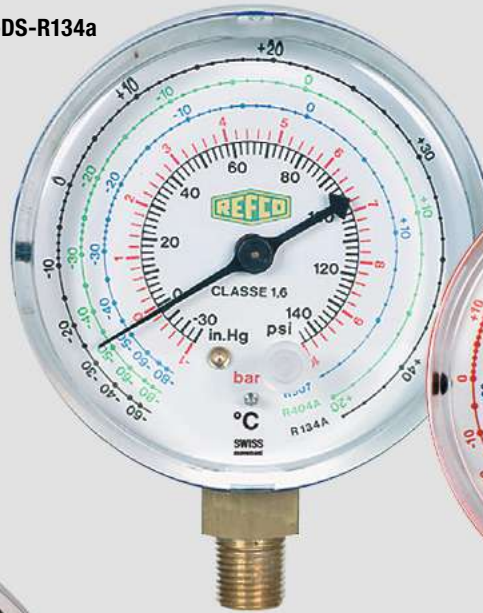

M2-500-DS-R22



SWISS
movement



M2-250-DS-R290



M2-250-M-R600a

压力表 - Pressure Gauges

波纹管型计量表 1级 - Bellow Type - Gauge Class 1

波纹管型计量表原理

Principle of Bellow Gauge

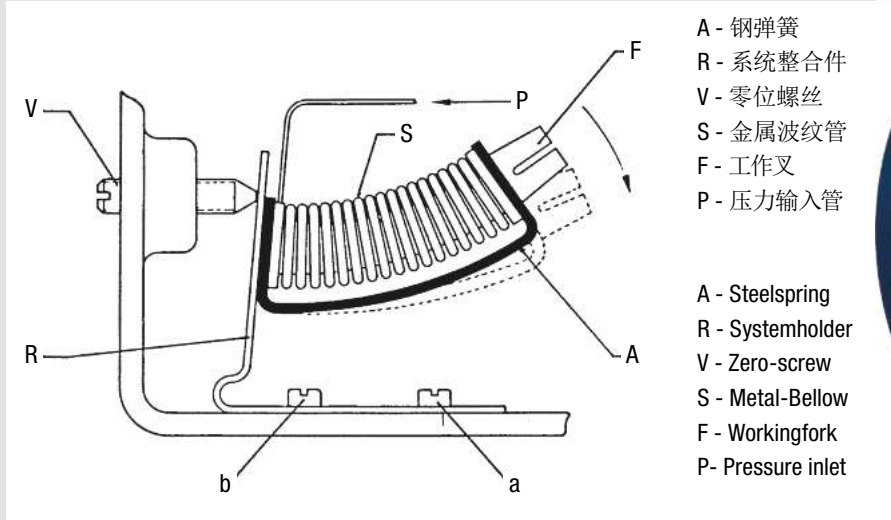

- A - 钢弹簧
- R - 系统整合件
- V - 零位螺丝
- S - 金属波纹管
- F - 工作叉
- P - 压力输入管

- A - Steelspring
- R - Systemholder
- V - Zero-screw
- S - Metal-Bellow
- F - Workingfork
- P- Pressure inlet



R5-220-DS-R22

金属波纹管型计量表灵敏度很高, 因而绝对精确 (1级)。

The metal-bellow-type gauges are very sensitive and therefore absolutely accurate (class 1).

加硬的钢弹簧A包括铜焊金属波纹管S。在无负荷状态下稍弯曲 (见图)。该组合由系统整合件R束缚在一起, 该整合件安装在计量表外壳a-b上。

The hardened steelspring A includes the brazed metal-bellow S and is slightly bent under a load (see drawing). This combination set is tied up with the system-holder R, which is mounted on the gauge-housing a - b.

工作叉F与计量表机械连接。如果压力P作用于计量表, 金属波纹管S将启动工作叉F, 而指针将在仪表上显示出正确的读数。

The workingfork F is connected with the gauge-mechanism. If pressure P is applied to the gauge the metal-bellow S will activate the workingfork F and the pointer will show correct reading on the scale.

金属波纹管型极端抗过压, 并根据精确度1级制造。例如, 如果25巴=350平方英寸磅的过压作用于一个介于-1至10巴-30+140平方英寸磅的复合计量表上, 指针将旋围2½圈。

Metal-bellow-type gauges are extremely over-pressure resistant and made according to accuracy class 1.

在释放了压力之后, 计量表仍完好无损, 而指针也仅稍微偏离零位螺丝V。

If for instance on a compound gauge with a range from -1 to 10 bar respectively -30 + 140 psi an overpressure of 25 bar = 350 psi is applied, the pointer will turn around 2 ½ times.

布顿型计量表绝对不可能经受此种过压, 将遭损坏。

After release of the pressure the gauge is still in perfect condition and the pointer should only be slightly re-calibrated with the zero-screw V.

A Bourdon-type gauge would never stand such an over-pressure and would be destroyed.



R5-320-M-R134a



++R5-320++

++R5-220++

名称 Designation	压力计 Pressure scale		温度计摄氏度 Temperature Scale °C Centigrade						部件号 Part No	
	bar*	psi*	R12	R22	R134a	R407C	R404A	R407		R410A
PM2-200-DS-R12 PM2-300-DS-R12	● ●	● ●	● ●	● ●	● ●					9886480 9886481
PM2-200-M-R134a PM2-300-M-R134a	● ●				● ●		● ●	● ●		9886377 9886378
PM2-200-DS-R134a PM2-300-DS-R134a	● ●	● ●			● ●		● ●	● ●		9886465 9886466
PM2-200-DS-R22 PM2-300-DS-R22	● ●	● ●		● ●	● ●		● ●			9884151 9884152
PM2-200-M-R407C PM2-300-M-R407C	● ●				● ●	● ●	● ●			4411323 4411331
PM2-200-DS-R410A** PM2-300-DS-R410A**	● ●	● ●							● ●	9884097 9884098

*bar - 巴 psi - 平方英寸磅

** 低压压力表用于R410A冷媒压力范围为-1至36巴或-30至520平方英寸磅, 高压压力范围为-1至54巴或-30至780平方英寸磅。

The lower pressure range on the gauges for R410A is -1 to 36bar/-30 to 520 psi, the high pressure range is -1 to 54 bar/-30 to 780 psi.

重要说明:

所有直径76毫米的计量表, 底部连接为 $\frac{1}{8}$ 英寸NPT。

如果需要使用 $\frac{1}{4}$ 英寸SAE照明连接, 务必将 $\frac{1}{4}$ 英寸SAE加在部件号之后。

例如, PM2-200- $\frac{1}{4}$ 英寸SAE。所有直径76毫米的计量表均提供背面连接。具有背面连接的计量表一概为 $\frac{1}{4}$ 英寸SAE。

如果需要背面连接, 请在部件号两边加上 (+) 号。

如: ++PM2-200++

Important:

All gauges with a diameter of 76 mm bottom connection $\frac{1}{8}$ " NPT.

If $\frac{1}{4}$ " SAE flare connection is required it is important to put behind the part number $\frac{1}{4}$ " SAE; for instance PM2-200- $\frac{1}{4}$ " SAE.

All gauges with 76 mm diameter are also available with back connection. Gauges with back connection are always $\frac{1}{4}$ " SAE.

If connection on the back is required please put on both sides of the part number the plus sign (+).

For instance: ++PM2-200++.



PM2-200-M-R134a



PM2-300-M-R134a

巴:

复合 -1 至 +10 巴
压力 -1 至 +30 巴

公斤/帕斯卡:

复合 -100 至 +1000 公斤/帕斯卡
压力 -100 至 +3000 公斤/帕斯卡

磅/平方英寸:

复合 -30 至 +140 磅/平方英寸
压力 -30 至 +400 磅/平方英寸

bar:

Compound -1 up to +10 bar
Pressure -1 up to +30 bar

kPa:

Compound -100 up to +1000 kPa
Pressure -100 up to +3000 kPa

psi:

Compound -30 up to +140 psi
Pressure -30 up to +400 psi

压力表 - Pressure Gauges



注油压力表 - 波纹管设计精度达 ±1% - 铝材外壳 - Oil Pressure Gauges - Bellow Types Gauge Class 1 - Aluminium housing

名称 Designation	毫米 Ø	直径 连接 Connection	注泊 Oil-filled	干 dry	压力计 Pressure scale	部件号 Part No
					0-10 bar/巴 0-25 bar/巴	
PM2-247-10	76	1/4" SAE				4419864
PM2-247-25	76	1/4" SAE				4412044
PM2-247-26	76	1/8" NPT				4412273
R3-248-10	60	1/4" SAE				9886459
R3-248-25	60	1/4" SAE				4412052
R3-248-26	60	1/8" NPT				9883816
++MR-245-DS-14++	63	1/4" SAE			14 bar	7203378
++MR-345-DS-35++	63	1/4" SAE			35 bar	7203467

RM = 玻璃纤维外壳 RM = Fiberglass housing
 R3 = 制外壳 R3 = Aluminium housing
 MR = 外壳 MR = Stainless steel housing



PM2-247-10

名称 Designation	直径 毫米 Ø mm	连接 Connection	注泊 Oil-filled	压力计 Pressure scale	温度计摄氏度 Temperature Scale	部件号 Part No
				bar* psi*	R22 R502 R134a R404A R507 R407C R410A R744 R290 R600 R600a	
R3-220-DS-R134a	60	1/8" NPT	●	● ●		9886365
R3-320-DS-R134a	60	1/8" NPT	●	● ●		9886366
R3-220-DS-R22	60	1/8" NPT	●	● ●	●	4458843
R3-320-DS-R22	60	1/8" NPT	●	● ●	●	4459025
R3-220-DS-R407C	60	1/8" NPT	●	● ●		4490496
R3-320-DS-R407C	60	1/8" NPT	●	● ●		4490500
R3-220-DS-R410A**	60	1/8" NPT	●	● ●		4457049
R3-320-DS-R410A**	60	1/8" NPT	●	● ●		4457057
R3-220-DS-CLIM**	60	1/8" NPT	●	● ●	●	4664341
R3-320-DS-CLIM**	60	1/8" NPT	●	● ●	●	4664359
R5-220-DS-R134a	80	1/8" NPT	●	● ●		9883636
R5-320-DS-R134a	80	1/8" NPT	●	● ●		9883635
R5-220-DS-R22	80	1/8" NPT	●	● ●	●	4490054
R5-320-DS-R22	80	1/8" NPT	●	● ●	●	4490062
R5-220-DS-R407C	80	1/8" NPT	●	● ●		9884598
R5-320-DS-R407C	80	1/8" NPT	●	● ●		9884599
R5-220-DS-R410A**	80	1/8" NPT	●	● ●		4505841
R5-320-DS-R410A**	80	1/8" NPT	●	● ●		4505850
R5-220-DS-CLIM**	80	1/8" NPT	●	● ●	●	4664295
R5-320-DS-CLIM**	80	1/8" NPT	●	● ●	●	4664302
R3-220-DS-R744-30BAR	60	1/8" NPT	●	● ●		4682667
R3-320-DS-R744-60BAR	60	1/8" NPT	●	● ●		4682676
R3-220-M-R290	60	1/8" NPT	●	● ●		4426712
R3-320-M-R290	60	1/8" NPT	●	● ●		4426721

*bar - 巴 psi - 平方英寸磅

** 低压压力表用于R410A冷煤压力范围为-1至36巴或-30至520平方英寸磅，
 高压压力范围为-1至54巴或-30至780平方英寸磅。

The lower pressure range on the gauges for R410A is -1 to 36bar/-30 to 520 psi, the high pressure range is -1 to 54 bar/-30 to 780 psi.

名称 Designation	直径 毫米 Ø mm	连接 Connection	注油 Oil-filled	压力计 Pressure scale		温度计摄氏度 Temperature Scale										部件号 Part No		
				bar*	psi*	R22	R134a	R404A	R507	R407C	R410A	R744	R290	R600	R600a			
R7-220-DS-R134a	100	1/4" SAE	●	●	●		●	●	●									9886422
R7-320-DS-R134a	100	1/4" SAE	●	●	●		●	●	●									9886423
R7-220-M-R407C	100	1/4" SAE	●	●			●	●			●							9884090
R7-320-M-R407C	100	1/4" SAE	●	●			●	●			●							9884091



重要说明:

所有直径60和80毫米的计量表，底部连接为1/8英寸NPT。
如果需要使用1/4英寸SAE照明连接，务必在部件号之后标明。例如，R3-220-1/4英寸SAE。
所有直径60, 80和100毫米的计量表均提供背面连接。具有背面连接的计量表一概为1/4英寸SAE。
如果需要背面连接，请在部件号两边加上 (+) 号。
如: ++R3-220++

可订造特别的表盘及其他温度-尺度。

Important:

All gauges with a diameter of 60 and 80 mm, bottom connection 1/8" NPT.
If 1/4" SAE flare connection is required it must be indicated behind the part number for instance R3-220-1/4" SAE.
All gauges with 60, 80 and 100 mm diameter are also available with back connection. Gauges with back connection are always 1/4" SAE.
If connection on the back is required please put on both sides of the part number the plus sign (+).
For instance: ++R3-220++

Special dials with other temperature-scales available on request.

巴:

复合 -1 至 +10 巴
压力 -1 至 +30 巴
公斤/帕斯卡:
复合 -100 至 +1000 公斤/帕斯卡
压力 -100 至 +3000 公斤/帕斯卡
磅/平方英寸:
复合 -30 至 +140 磅/平方英寸
压力 -30 至 +400 磅/平方英寸

bar:

Compound -1 up to +10 bar
Pressure -1 up to +30 bar
kPa:
Compound -100 up to +1000 kPa
Pressure -100 up to +3000 kPa
psi:
Compound -30 up to +140 psi
Pressure -30 up to +400 psi



压力表 - Pressure Gauges

SWISS
movement

布顿型计量表 - Bourdon Type Gauges

布顿型计量表直径68毫米，不锈钢外壳，注油，巴/平方英寸刻度，级别1.6，连接为1/4英寸SAE直径。

Bourdon type gauge \varnothing 68 mm, stainless housing, oilfilled, scale bar / psi, class 1.6, connection 1/4" SAE.

名称 Designation	部件号 Part No
MR-200-DS-R22	7648597
MR-300-DS-R12	7648601
MR-200-DS-R134a	7649232
MR-300-DS-R134a	7649372

表(含泊设计)脚部
1/8英寸NPT英制接口。

Gauges as above but with
connection 1/8" NPT.

名称 Designation	部件号 Part No
MR-202-DS-R22	7413012
MR-302-DS-R12	7413020
MR-202-DS-R134a	7413046
MR-302-DS-R134a	7413098



MR-300-DS-R22



++MR-205-DS-CLIM++

SWISS movement



MR-206-DS-MULTI-16BAR

巴:
复合 -1 至 +10 巴
压力 -1 至 +30 巴
磅/平方英寸:
复合 -30 至 +140 磅/平方英寸
压力 -30 至 +400 磅/平方英寸

bar:
Compound -1 up to +10 bar
Pressure -1 up to +30 bar
psi:
Compound -30 up to +140 psi
Pressure -30 up to +400 psi

压力表的 MR-200/-300 系列, 安装的法兰在表前面, 而接驳口在背部口径是 1/4" SAE.

Gauges as MR-200/-300 series, but ring for front mounting, backside connection 1/4" SAE.

名称 Designation	部件号 Part No
++MR-205-DS-R12++	7870524
++MR-305-DS-R12++	7870532
++MR-205-DS-R22++	7870443
++MR-305-DS-R12++	7870451
++MR-205-DS-R134a++	7870354
++MR-305-DS-R134a++	7870389
++MR-205-DS-R32++	4686945
++MR-305-DS-R32++	4686946
++MR-205-DS-CLIM++	4677745
++MR-305-DS-CLIM++	4677761
++MR-205-DS-MULTI-16BAR++	7230587
++MR-305-DS-MULTI-35BAR++	4664430

压力表的 MR-200 /-300 系列, 安装法兰的在表底部, 而驳口在下部口径是 1/4" SAE.

Gauges as MR-200/-300 series, but ring for back mounting, connection 1/4" SAE.

名称 Designation	部件号 Part No
MR-206-DS-R12	4503679
MR-306-DS-R12	4503687
MR-206-DS-R22	7196101
MR-306-DS-R12	7196119
MR-206-DS-R134a	4503695
MR-206-DS-R134a	4503708
MR-306-DS-R407C	7433650
MR-306-DS-R407C	7433693
MR-206-DS-R32	4686926
MR-306-DS-R32	4686927
MR-206-DS-MULTI-16BAR	4664448
MR-306-DS-MULTI-35BAR	4664456

真空表 - Vacuum Gauges



真空表 - Vacuum Gauges

19800-SV

真空表及安全阀
直径80毫米, 连接为 $\frac{1}{8}$ 英寸NPT,
可重新校准, 刻度为1000至0毫巴。
部件号 **9882473**

19800-SV

Vacuum Gauge with safety valve
Diameter 80 mm, connection $\frac{1}{8}$ " NPT,
recalibratable, scale 1000-0 mbar:
Part No **9882473**



19805-12



19800-SV

19805-12/2

单件安全阀, 可用于部件
19800-SV, 19801, 19805。
部件号 **4687078**, 2个/包

19805-12/2

Safety valve only, ready for use on item
19800-SV, 19801, 19805。
Part No **4687078**, 2 pcs.

19801

真空计1000至0豪巴
 直径: 100毫米
 连接: ½英寸, G
 配有最大读数仪表指针
 指示任一指定期间所达
 到的最大压力读数。可
 以指旋螺丝重新调节。
 部件号 **9882474**

19801

Vacuum Gauge 1000 to 0 mbar
 Diameter: 100 mm
 Connection: ½" G
 With maxi-reading gauge pointer indicates
 maximum pressure reading attained
 during any given period. Readjust with
 thumb screw.
 Part No **9882474**

19621

绝对真空表
 读数从150至0豪巴
 直径: 100毫米
 连接: ½英寸G, 包括调节器
 ½英寸G x ¼英寸SAE (项目19803)。
 本表并不补偿气压, 因此, 有
 效真空将得到测量。
 部件号 **9882476**

19621

Absolute-Vacuum Gauge
 reading from 150 to 0 mbar
 Diameter: 100 mm
 Connection: ½" G
 Including adapter ½" G x ¼" SAE (Art. 19803).
 This instrument does compensate the
 atmospheric pressure, therefore the effective
 vacuum will be measured.
 Part No **9882476**

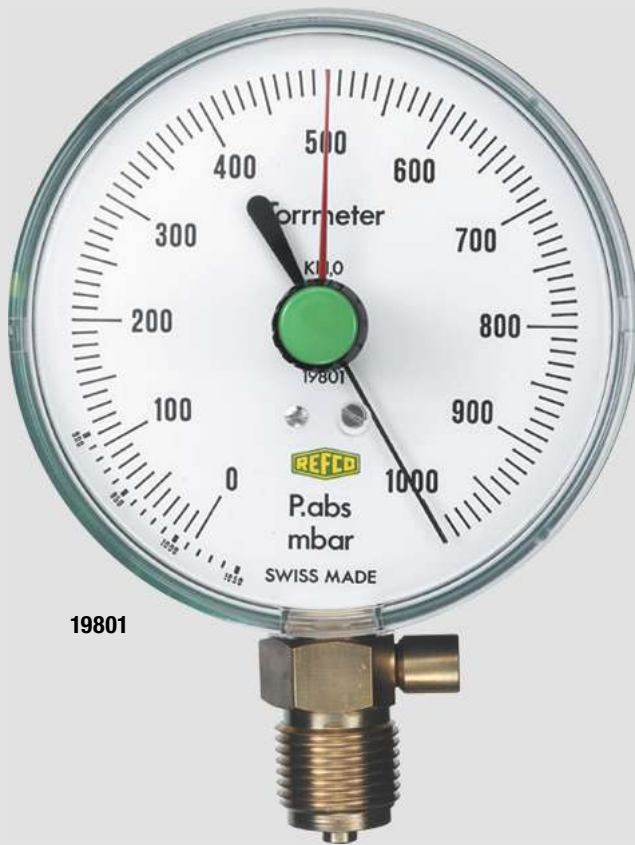

19801

SWISS MADE



19621

真空表 - Vacuum Gauges

电子真空表 - Digital Vacuum Gauges

REF-VAC

电子真空表是最新测量仪器，可连续阅读数字真空测量数值中疏散的过程。该装置还具有实用的钩挂，符合IP分类54。

传感器类型: 电热偶
 真空范围: 0-18000微米
 显示分辨率: 0.2微米
 单位: 微米, 微帕斯卡, 托, 微托, 磅
 准确性: 0-20: 0.2微米
 20-200: 1微米
 200-500: 5微米
 连接器: 标准1/4英寸
 工作温度范围: 0 °C-40 °C
 自动关闭: 30分钟后
 电池寿命: 40小时
 包括: **T6-4 三通 3 x 1/4"**
 喇叭口
 超出压力: 最大34巴
 部件号 **4686712**



REF-VAC

REF-VAC

Latest measuring instrument for continuous reading of measured values during the evacuation process out in the field as well as in the laboratory. Thanks to the large LCD display, the changing data can always be read easily. The vacuum gauge can be set to the main vacuum units such as microns, mbar, Pa, Torr, mTorr, psi and inHG. It can accurately display the vacuum from 18000 - 0 microns. The unit also has a practical hook for hanging and conforms to the classification IP 54.

Sensor Type: Thermistor
 Vacuum Range: 0-18000 microns
 Display-Resolution: 0-20: 0.2 microns
 21-200: 1 microns
 201-500: 5 microns
 Units: microns, mbar, Pa, Torr, mTorr, psi, inHG
 Accuracy: +/-10% -100 microns
 +/- 6% -101-750 microns
 ConnectorType: Standard male 1/4 inch SAE
 Operating Temp. Range: 0 °C-40 °C
 Auto Shutoff: After 10 min. if vacuum value greater than 18000 microns After 30 min. if vacuum value less than 18000 microns
 Battery life : 40 hours
Delivered with: T6-4 Forged flare branch tee 3 x 1/4" SAE
 Overpressure : Max. 34 bar
Part No 4686712

新的三通喇叭口
 New with Forged Brass Tee



RL-VAC

RL-VAC

真空表连接1/4" SAE
 球阀用于真空泵。
 部件号 **4663981**

RL-VAC

Vacuum gauge set with ball valve 1/4" SAE for vacuum pumps.
Part No 4663981

REF-CLASS-GAUGE

电子数码压力计量表的概念是源自一个类似的计量表,用数码校准器把它提高到一个新的水平。

REF-CLASS-GAUGE是结合精确的数字技术与简单的计量表。它是实现了高性能的,易于使用的,是在压力测量领域里功能无可匹敌的。

这种多功能性的高端产品是可以带给你很多好处的。该计量仪可以让你自己测量压力仪表及有助于节省成本。例如与数码复式接头 "DIGIMON"可以很容易地校准内部。

“在REF-CLASS-GAUGE提供了一个合适的,简洁的解决方案,以执行对压力的校准。安装快捷简单,透过显示屏的目录驱动程式提供直观的功能。这种精密的设备包装在坚固的手提箱内。

- 在任何压力的现场‘如实验室或车间都很容易地做压力测试
 - 用于测试, 设置和校准任何压力表
 - 气动压力产生-950 mbar至+35 bar
 - 符合人体工程学的处理
 - 通过精细控制阀能精确地较准
 - 精确度: 0.05%FS (在包括校准证书)的压力和温度测量
 - 坚固耐用的不锈钢外壳符合
 - 数据记录器功能
 - 数据解释软件的需求
- 部件号 **4682293**



REF-CLASS-GAUGE

The digital pressure test gauge takes the concept of an analog gauge, and brings it to a new level, as only digital calibrators can do. The REF-CLASS-GAUGE combines the accuracy of digital technology with the simplicity of an analog gauge. It achieves performance, ease-of-use and features unmatched in the pressure measurement world.

The versatility of this high-end product is your benefit. The REF-CLASS-GAUGE allows you to test the pressure of gauges on your own and in addition helps to save costs. For instance the digital manifold "DIGIMON" can easily be calibrated in-house.

The REF-CLASS-GAUGE offers a comfortable and compact solution in order to perform pressure calibration on-site. The setup is fast and straightforward, through a menu-driven display with minimal test and intuitive functions.

A carrying case protects this precision device in a perfect way.

- Simple generation of test pressure on-site, in lab or in the shop floor
 - For testing, setting and calibrating of any pressure gauges
 - Pneumatic pressure generation of -950 mbar to +35 bar
 - Ergonomic handling
 - Precise alignment through fine-control valve
 - Accuracy: 0.05% FS (incl. calibration certificate) for pressure-and temperature measurement
 - Rugged stainless steel case meets NEMA4/IP65
 - Data logger function
 - Data interpretation software on demand
- Part No 4682293**

REF-CLASS-GAUGE

复式接头 - Manifolds



BM2-8-DS-R410A



APEX-8-DS-R22



DIGIMON-SE

一般资料

压力计:

M	=	公制、巴
DS	=	双级计量仪巴/每平方英寸
KPA	=	kPa/ 每平方英寸

请在订单上注明您的要求。

温度计:

R12-N	=	R12/R22/R134a
R134a	=	R134a/R404A/R507
R22	=	R22/R134a/R404A
R407C	=	R407C/R134a/R404A
R410A	=	R410A
CLIM	=	R22/R407C/R410A
R32	=	R32/R410A
R1234yf	=	R1234yf/R134a
R744	=	CO2 subcritical state
R290	=	R290/R600/R600a

以上所未列出的制冷计量度计可应要求提供。

压力表的压力范围

巴:	
复合	-1 至 +10 巴
压力	-1 至 +30 巴
公斤/帕斯卡:	
复合	-100 至 +1000 公斤/帕斯卡
压力	-100 至 +3000 公斤/帕斯卡
磅/平方英寸:	
复合	-30 至 +140 磅/平方英寸
压力	-30 至 +400 磅/平方英寸

R410A	
巴:	
复合	-1 至 +36 巴
压力	-1 至 +54 巴
公斤/帕斯卡:	
复合	-100 至 +3600 公斤/帕斯卡
压力	-100 至 +5400 公斤/帕斯卡
磅/平方英寸:	
复合	-30 至 +520 磅/平方英寸
压力	-30 至 +780 磅/平方英寸

General information

Pressure scale:

M	=	metric, bar
DS	=	double scale bar/psi
KPA	=	kPa/psi

Please indicate request on your order.

Temperature scale:

R12-N	=	R12/R22/R134a
R134a	=	R134a/R404A/R507
R22	=	R22/R134a/R404A
R407C	=	R407C/R134a/R404A
R410A	=	R410A
CLIM	=	R22/R407C/R410A
R32	=	R32/R410A
R1234yf	=	R1234yf/R134a
R744	=	CO2 subcritical state
R290	=	R290/R600/R600a

Temperature scales for other than the above indicated refrigerants are available on request.

Pressure range of gauges

bar:	
Compound	-1 up to +10 bar
Pressure	-1 up to +30 bar
kPa:	
Compound	-100 up to +1000 kPa
Pressure	-100 up to +3000 kPa
psi:	
Compound	-30 up to +140 psi
Pressure	-30 up to +400 psi

R410A	
bar:	
Compound	-1 up to +36 bar
Pressure	-1 up to +54 bar
kPa:	
Compound	-100 up to +3600 kPa
Pressure	-100 up to +5400 kPa
psi:	
Compound	-30 up to +520 psi
Pressure	-30 up to +780 psi

复式接头 - Digital Manifold



电子支管仪 - Two-way digital manifold

DIGIMON-SE

DIGIMON-SE最新一代的特点是紧凑的设计和坚固的结构。
过冷/过热的真空度和泄漏性试验，会随着压力和温度读数显示。
DIGIMON符合用于数字歧管的要求，可用的配件包括K型热电偶，以及外部真空传感器。

软件数据:

- >50制冷剂包括: R410A, R32, R744(CO2), R1234yf/R1234ze
- 模拟和数字显示
- 精确度等级: 1.0
- 压力的分辨率: 0.01巴/0.5psi/1千帕/0.001兆帕
- 压力表从-0.95巴到+60巴
- 过热和过冷的直接计算和显示
- 2个精确的K型真空传感器
- 内部及外部的真空传感器
- 泄漏测试功能
- 背光的LCD显示屏具有多重保护
- 用户友好的操作系统
- 纤维增强人体工程学旋钮
- 自动省电模式
- 低电量指示灯
- 持续测量

Two-way digital manifold

DIGIMON-SE-8

电子双路歧管仪，附带两个K-型温度传感器，装在一个坚固的塑料外壳内。
部件号 4686735

DIGIMON-SE-3-PLUS

电子双路支管仪包含3条充气软管，1/4英寸SAE(蓝色，红色和黄色)，长度为60英寸(150厘米)及2条1/2英寸-20 UNF(蓝色，红色)长度为60英寸(150厘米)充气软管连接，产品包装坚固的塑料盒方便保存。
部件号 4686736

DIGIMON-SE-3-PLUS-CA

CA阀软管与DIGIMON-SE-3-PLUS版本相同。
部件号 4686738

DIGIMON-SE-3-PLUS-CLAMP

电子双向歧管仪包括电偶钳。
部件号 4686737

DIGIMON-SE-3-PLUS-CLAMP-VAC

组合电子双向歧管仪，电偶钳，电子真空表。
部件号 4686739



DIGIMON-SE



模拟视图
Analog view

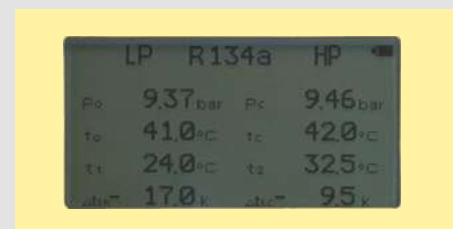

过热度和过冷度功能
Superheat and Subcool function

DIGIMON-SE

User friendly 2-way and 4-way digital manifold for the efficient and safe maintenance and operation of air conditioning and refrigeration systems. The latest generation is characterized by its compact design and sturdy construction. The modern display allows for, superheating, subcooling, vacuum levels and leakage test to be shown along with the pressure and temperature reading. Additionally, in analog mode, the digital figures are displayed visually. The DIGIMON meets the most important requirements for a digital manifold and is available in various versions. Available accessories include K-type thermocouple as well as an external vacuum sensor.

Technical Data:

- >50 Refrigerant tables incl. R410A, R32, R744(CO2), R1234yf/R1234ze
- Analog- and Digital Display
- Accuracy: Class 1.0
- Pressure resolution: 0.01 bar / 0.5 psi / 1 kPa / 0.001 MPa
- Pressure Gauge from -0,95 bar to +60 bar
- Direct calculation and display of superheat- and subcool
- 2 precise K-Type temperature sensors
- Internal and external vacuum sensor
- Leak-test function
- Backlit LCD display with multiple protection
- User-friendly operation
- Fiber Reinforced ergonomic knobs
- Automatic power-save mode
- Low battery indicator
- Continuous measuring rate

Two-way digital manifold

DIGIMON-SE-8

Digital two-way manifold, with 2 K-Type temperature sensors, packed in a sturdy plastic case.

Part No 4686735

DIGIMON-SE-3-PLUS

Digital two-way manifold with 3 charging lines ¼" SAE blue, red and yellow, length 60 inches (150 cm), as well as two charging lines (blue and red) length 60 inches (150 cm) with ½"-20UNF connection on one end, packed in a sturdy plastic case.

Part No 4686736

DIGIMON-SE-3-PLUS-CA

Same version as the DIGIMON-SE-3-PLUS but with hoses with CA valves.

Part No 4686738

DIGIMON-SE-3-PLUS-CLAMP

DIGIMON-SE-3-PLUS including the DIGIMON-CLAMP.

Part No 4686737

DIGIMON-SE-3-PLUS-CLAMP-VAC

Combination of DIGIMON-SE-3-PLUS, DIGIMON-CLAMP and DIGIMON-VAC.

Part No 4686739



真空读数与 DIGIMON-VAC
Vacuum reading with DIGIMON-VAC

DIGIMON-SE-3-PLUS-CLAMP-VAC

复式接头 - Digital Manifold

SWISSMADE

电子支管仪 - Four-way digital manifold

DIGIMON4-3-PLUS

电路四路支管仪包含3条充气管, 1/4英寸SAE(蓝色, 红色和黄色)长度为60英寸(150厘米)及两条1/2英寸-20UNF(蓝色和红色)及两条1/2英寸-20UNF(蓝色和红色), 长度为60英寸(150厘米)充气软管连接, 产品包装坚固的塑料方便保。

部件号 4686740

DIGIMON4-3-PLUS-CA-CLAMP-VAC

CA阀配备组合有电路四路支管仪, 电偶钳和电子真空表。

部件号 4686741

DIGIMON4-3-PLUS

Digital four-way manifold with 3 charging lines 1/4" SAE blue, red and yellow, length 60 inches (150 cm), as well as two charging lines (blue and red) length 60 inches (150 cm) with 1/2" - 20 UNF connection on one end, packed in a sturdy plastic case.

Part No 4686740

DIGIMON4-3-PLUS-CA-CLAMP-VAC

Combination of DIGIMON4-3-PLUS, DIGIMON-CLAMP and DIGIMON-VAC, equipped with CA valves.

Part No 4686741



DIGIMON4

DIGIMON 的配件和备件

DIGIMON-SENSOR-K-TYPE

外部K型传感器

部件号 4681394

DIGIMON-CLAMP

K热电偶钳

温度范围: -40 °C至+125 °C

钳口范围: 6毫米至38毫米

精确度: ±1 °C

分辨率: 0.1 °C

部件号 4681466

DIGIMON-VAC

外部真空传感器

部件号 4686713

DIGIMON-SE-CASE

手提箱DIGIMON-SE和DIGIMON4

部件号 4686730

M2-10-95-R/4

全套阀门组活塞4个, 垫圈2个

部件号 4687105

M4-6-04-R/10

活塞10个, 垫圈2个

部件号 4662624

M4-7-SET-B+R

手轮蓝色和红色

部件号 4687396

M4-7-SET-B+N+R+Y

手轮蓝色, 黑色, 红色, 黄色

部件号 4687094

Accessories and spare parts for DIGIMON

DIGIMON-SENSOR-K-Type

External K type plug

Part No 4681394

DIGIMON-CLAMP

K-type clamp thermocouple

Temperature range: -40 °C to +125 °C

Jaw range: 6 mm to 38 mm

Accuracy: ±1 °C

Resolution: 0.1 °C

Part No 4681466

DIGIMON-VAC

External vacuum sensor

Part No 4686713

DIGIMON-SE-CASE

Carrying case for DIGIMON-SE and DIGIMON4

Part No 4686730

M2-10-95-R/4

Complete valve set with 2 gaskets, 4 pcs.

Part No 4687105

M4-6-04-R/10

Piston including 2 gaskets, 10 pcs.

Part No 4662624

M4-7-SET-B+R

Handwheel blue and red

Part No 4687396

M4-7-SET-B+N+R+Y

Handwheel blue, black, red, yellow

Part No 4687094



DIGIMON-CLAMP



M2-10-95-R



M4-6-04-R



DIGIMON-VAC



M4-7-SET-B+N+R+Y

DIGIMON

Swiss digital manifold

瑞士電子冷媒錶組

HVAC/R
Service Products



- Accuracy class 1.0



- Superheat and Subcool function



- Values can be saved
- Backlit LCD display with multiple protection
- Automatic power-save mode
- Continuous measuring rate

Low pressure indication

More than 50 refrigerant tables including:
R410A, R744 (C02), R32, R1234yf/R1234ze

High pressure indication

Low battery indicator

2 K-type
temperature sensors

Handwheel



Complete valve set
including piston



Sight glass for easy process control

Key to change manifold sight glass



Assembly of sight glass, 2 gaskets
and threaded brass ring



Accessories available:

- DIGIMON-CLAMP
- DIGIMON-VAC



External
vacuum sensor



SWISSMADE

瑞士製造

REFCO Manufacturing Ltd.
6285 Hitzkirch - Switzerland
www.refco.ch

產品供R410A 及R32 - Products for R410A and R32

于新制冷剂R410A的计量表、复式接头及充气线 - Gauges for the refrigerant R410A

以R410A充气的机组要求计量表具备更高的压力范围，其软管具备不同的接头和压力。标准的 R410A接头为 1/2 英寸-20 UNF (5/16英寸SAE)。

红色和蓝色[威科]充气线配备有1/2英寸-20 UNF (5/16英寸SAE)。

红色和蓝色[威科]充气线配备有1/2英寸-20 UNF接头，在机组部分装有核心降压器，复式接头部分装有1/4英寸SAE。黄色充气线有1/4英寸SAE接头，两头均装有核心压缩机，充气线施加压力为60 巴/870平方英寸磅。

计量表的低压范围为-1 至-36巴/-30至520平方英寸磅；高压范围为-1至54巴/-30至780平方英寸磅。

Units charged with R410A require gauges with higher pressure ranges as well as hoses with different connections and working pressures. The standard connection for R410A is 1/2"-20 UNF (5/16"SAE). The red and blue REFCO charging lines are equipped with a connection 1/2"-20 UNF. On the manifold side they have 1/4" SAE connection. The yellow charging lines have 1/4" SAE connection with core depressor on both sides. The working pressure of the charging lines is 60 bar/870 psi.

The low pressure range on the gauges is -1 to 36 bar/-30 to 520 psi, the high pressure range is -1 to 54 bar/-30 to 780 psi.



M2-255-DS-R410A



PM2-300-DS-R410A

计量表

M2-255-DS-R410A

复合bourdon型计量表，1.6级，直径68毫米，接头1/8英寸NPT
部件号 7455896

M2-555-DS-R410A

同上，为压力表
部件号 7456001

PM2-200-DS-R410A

复合波纹管式计量表，1.0级，直径77毫米，接头1/8英寸NPT
部件号 9884097

PM2-300-DS-R410A

同上，为压力表
部件号 9884098

R3-220-DS-R410A

复合波纹管式计量表，1.0级，注油，铝制外壳，直径69.5毫米
部件号 4457049

R3-320-DS-R410A

同上，为压力表
部件号 4457057



R3-320-DS-R410A

Gauges

M2-255-DS-R410A

Compound bourdon type gauge class 1.6, Ø 68 mm, connection 1/8" NPT
Part No 7455896

M2-555-DS-R410A

As above, but pressure gauge
Part No 7456001

PM2-200-DS-R410A

Compound bellow gauge class 1.0, Ø 77 mm, connection 1/8" NPT
Part No 9884097

PM2-300-DS-R410A

As above, but pressure gauge
Part No 9884098

R3-220-DS-R410A

Compound bellow gauge class 1.0, oil-filled, Aluminium housing, Ø 69.5 mm
Part No 4457049

R3-320-DS-R410A

As above, but pressure gauge
Part No 4457057

Swiss manifold

瑞士冷媒錶組

HVAC/R
Service Products



With premium Bourdon Type Gauges
Gauge internals are all brass no plastic pieces

68 mm outside \varnothing

Accuracy class 1.6



Colour-coded

For easy high and low side identification



Zero point adjustable

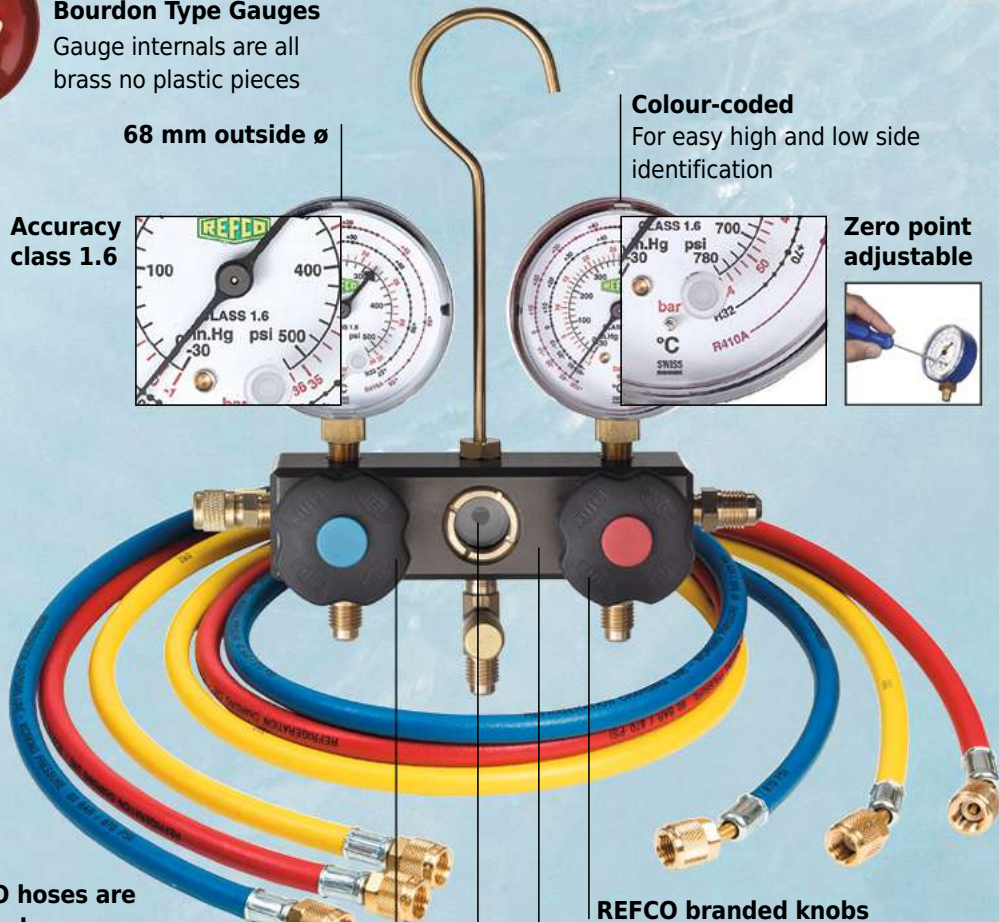

All REFCO hoses are SWISS Made

- Suitable for all common refrigerants
- Supplied with PTFE gaskets
- Available sizes: 90 cm, 150 cm, 180 cm



REFCO branded knobs

High quality aluminium body
made in Switzerland

Sight glass for easy process control

Key to change manifold sight glass



Assembly of sight glass, 2 gaskets and threaded brass ring



Handwheel



Complete valve set including piston



SWISS MADE

瑞士製造

REFCO Manufacturing Ltd.
6285 Hitzkirch - Switzerland
www.refco.ch

產品供R410A 及R32 - Products for R410A and R32

压力表组供R410A 及R32 - Manifolds for R410A and R32

SWISSMADE

BM2-3-DS-R410A

用于Bourdon型计量表的双向复式接头, 包括吊钩、三条编号充气线接头、 $\frac{1}{2}$ 英寸-20UNF (蓝色、红色)及 $\frac{1}{4}$ 英寸SAE (黄色), 长度36英寸 (90厘米), 包装于坚固的塑料箱中。

部件号 9884707

BM2-6-DS-R410A

同上, 但紙盒包装

部件号 4661180

M2-3-DS-R410A

用于标准波纹管式型计量表的双向复式接头, 1级, 包括吊钩、三条编号充气线接头 $\frac{1}{2}$ 英寸-20 UNF (蓝色、红色) 及 $\frac{1}{4}$ 英寸SAE (黄色)。长度36英寸 (90厘米), 包装于坚固的塑料箱中。

部件号 9884093

M4-3-DS-R410A

用于标准波纹管式型计量表的四向复式接头, 1级, 包括吊钩、三条编号充气线接头 $\frac{1}{2}$ 英寸-20 UNF (蓝色、红色) 及 $\frac{1}{4}$ 英寸SAE (黄色)。长度36英寸 (90厘米), 包装于坚固的塑箱中。

部件号 9884092

BM2-3-DS-R32

用于注油波纹管式型计量表的双向复式接头, 1级, 包括吊钩、三条编号充气线接头 $\frac{1}{2}$ 英寸-20 UNF (蓝色、红色) 及 $\frac{1}{4}$ 英寸SAE (黄色)。长度36英寸 (90厘米), 包装于坚固的塑料箱中。

部件号 4686947

BM2-6-DS-R32

用于注油波纹管式型计量表的四向复式接头, 1级, 包括吊钩、三条编号充气线接头 $\frac{1}{2}$ 英寸-20 UNF (蓝色、红色) 及 $\frac{1}{4}$ 英寸SAE (黄色)。长度36英寸 (90厘米), 包装于坚固的塑箱中。

部件号 4686948

BM2-3-DS-R410A

Two-way manifold with Bourdon type gauges, hook, 3 charging lines connection $\frac{1}{2}$ "-20 UNF (blue, red) and $\frac{1}{4}$ " SAE (yellow), length 36 inches (90 cm), in a sturdy plastic case.

Part No 9884707

BM2-6-DS-R410A

Same as above but packed in cardboard box

Part No 4661180

M2-3-DS-R410A

Two-way manifold with standard bellow type gauges class 1, hook, 3 charging lines connection $\frac{1}{2}$ "-20 UNF (blue, red) and $\frac{1}{4}$ " SAE (yellow) length 36 inches (90 cm), in a sturdy plastic case.

Part No 9884093

M4-3-DS-R410A

Four-way manifold with standard bellow type gauges class 1, hook, 3 charging lines connection $\frac{1}{2}$ "-20 UNF (blue, red) and $\frac{1}{4}$ " SAE (yellow) length 36 inches (90 cm), in a sturdy plastic case.

Part No 9884092

BM2-3-DS-R32

Two-way manifold with Bourdon type gauges, hook, 3 charging lines connection $\frac{1}{2}$ "-20 UNF (blue, red) and $\frac{1}{4}$ " SAE (yellow), length 36 inches (90 cm), in a sturdy plastic case.

Part No 4686947

BM2-6-DS-R32

Two-way manifold with Bourdon type gauges, hook, 3 charging lines connection $\frac{1}{2}$ "-20 UNF (blue, red) and $\frac{1}{4}$ " SAE (yellow), length 36 inches (90 cm), packed in cardboard box.

Part No 4686948



BM2-3-DS-R32

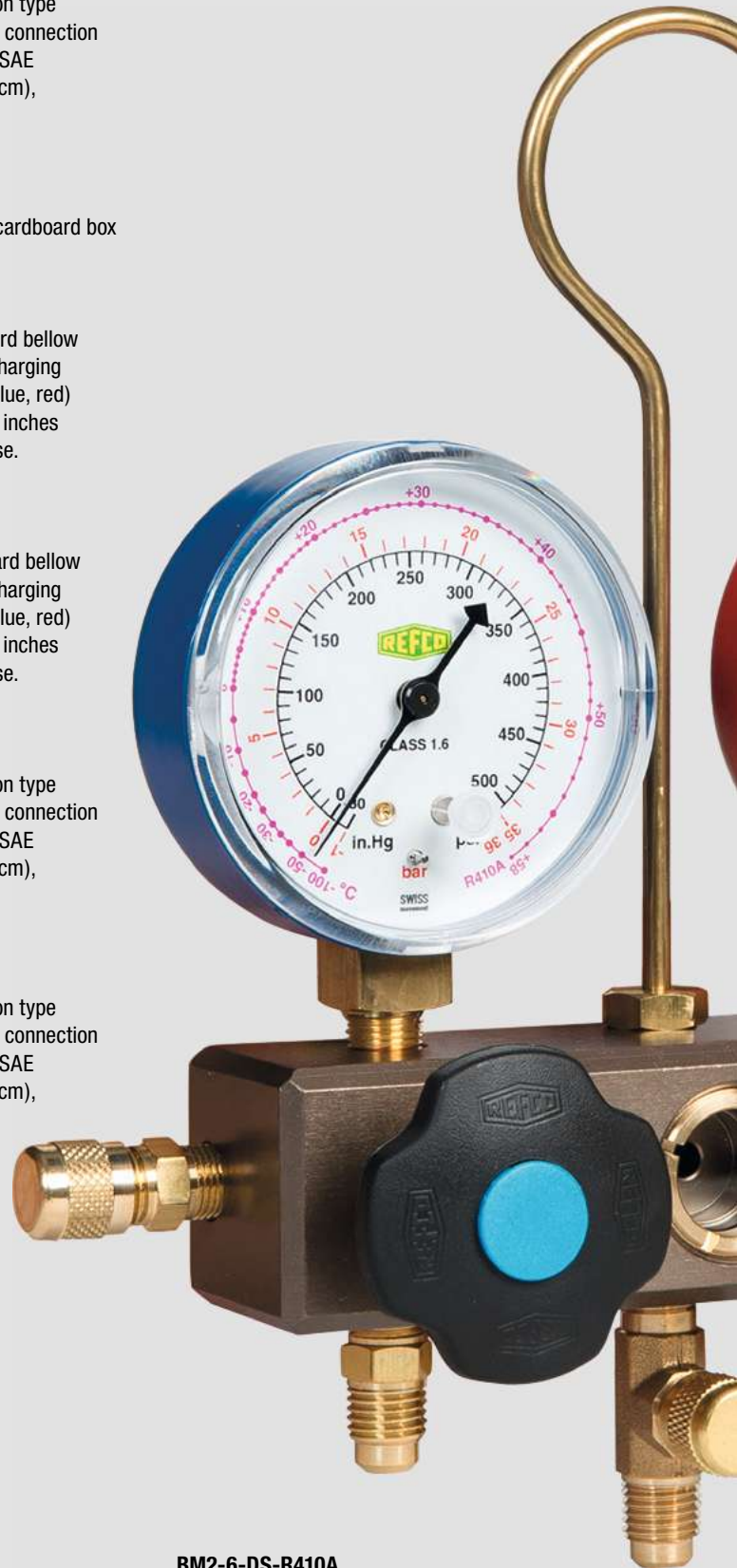

BM2-6-DS-R410A

复式接头R22, R407C, R410A

BM2-3-DS-CLIM

双向复式接头配有布顿式仪表, 挂钩, 三条充气管, 接头1/4英寸SAE, 配有蓝色、红色、黄色, 长度36英寸(90厘米), 以及另外两条(蓝、红)的充气管, 长36英寸(90厘米)1/2英寸-20 UNF接头, 包装于坚固塑料箱中。

部件号 4663506

BM2-6-DS-CLIM

基本上与BM2-3-DS-CLIM无异, 放于纸盒内。

部件号 4663298

BM2-8-DS-CLIM

双向复式接头, 配有布顿式仪表, 挂钩, 但是没有其他配件在盒子里。

部件号 4664015

BM4-3-DS-R410A

用于Bourdon型计量表包括吊销, 三条编号充气管接头, 1/2英寸-20 UNF(蓝色, 红色)及1/4英寸SAE(黄色), 长度36英寸(90厘米)包装于坚固的塑料箱中。

部件号 4663833

Manifolds R22, R407C, R410A

BM2-3-DS-CLIM

Two-way manifold with Bourdon type gauges, hook, 3 charging lines 1/4" SAE blue, red and yellow, length 36 inches (90 cm), as well as two charging lines (blue and red) length 36 inches (90 cm) with 1/2"-20 UNF connection on one end, packed in a sturdy plastic case.

Part No 4663506

BM2-6-DS-CLIM

Two-way manifold with Bourdon type gauges, hook, 3 charging lines 1/4" SAE blue, red and yellow, length 36 inches (90 cm), as well as two charging lines (blue and red) length 36 inches (90 cm) with 1/2"-20 UNF connection on one end, packed in cardboard box.

Part No 4663298

BM2-8-DS-CLIM

Two-way manifold with Bourdon type gauges, hook, without accessories, packed in cardboard box.

Part No 4664015

BM4-3-DS-R410A

with Bourdon type gauges, hook, 3 charging lines connection 1/2"-20 UNF (blue and red) and 1/4" SAE (yellow), length 36 inches (90 cm), packed in a sturdy plastic case.

Part No 4663833



BM2-8-DS-CLIM



BM4-3-DS-R410A



BM2-3-DS-CLIM

產品供R410A 及R32 - Products for R410A and R32

R410A 充气线 - Charging hoses for R410A



R410A充气线

红色和蓝色[威科]充气线配备有1/2英寸-20 UNF接头。复式接头部份装有1/4英寸SAE。黄色充气线有1/4英寸SAE接头，两头均装有核心压缩机。充气线施加压力为60巴/870（平方英寸磅）。

Charging hoses for R410A

The red and blue REFCO charging lines are equipped with a connection 1/2"-20 UNF. On the manifold side they have 1/4" SAE connection. The yellow charging lines have 1/4" SAE connection with core depressor on both sides. The working pressure of the charging lines is 60 bar/870 psi.

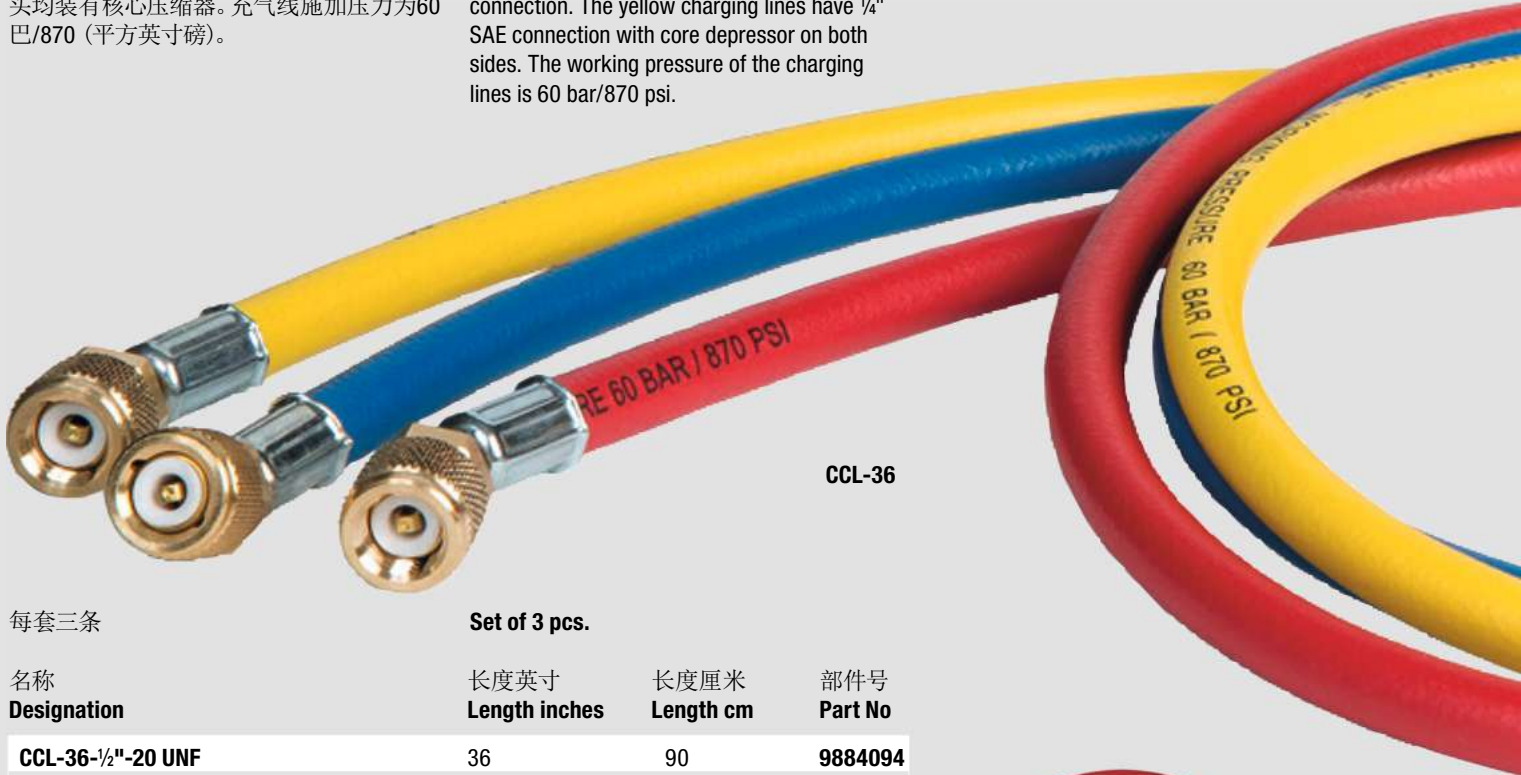

CCL-36

每套三条

Set of 3 pcs.

名称 Designation	长度英寸 Length inches	长度厘米 Length cm	部件号 Part No
CCL-36-1/2"-20 UNF	36	90	9884094
CCL-60-1/2"-20 UNF	60	150	9884095

配CX阀软件
每套三条

Hoses with CX-valves
Set of 3 pcs.

名称 Designation	长度英寸 Length inches	长度厘米 Length cm	部件号 Part No
CCL-36-CX-1/2"-20 UNF	36	90	9884096



CCL-36-1/2"-20 UNF-1/4" SAE

配CA阀软件
每套三条

Hoses with CA-valves
Set of 3 pcs.

名称 Designation	长度英寸 Length inches	长度厘米 Length cm	部件号 Part No
CCL-36-CA-1/2"-20 UNF	36	90	4666484
CCL-60-CA-1/2"-20 UNF	60	150	4666522
CA-CCL-60-1/2"-20 UNF	60	150	4682519



CCL-36-CA-1/2"-20 UNF

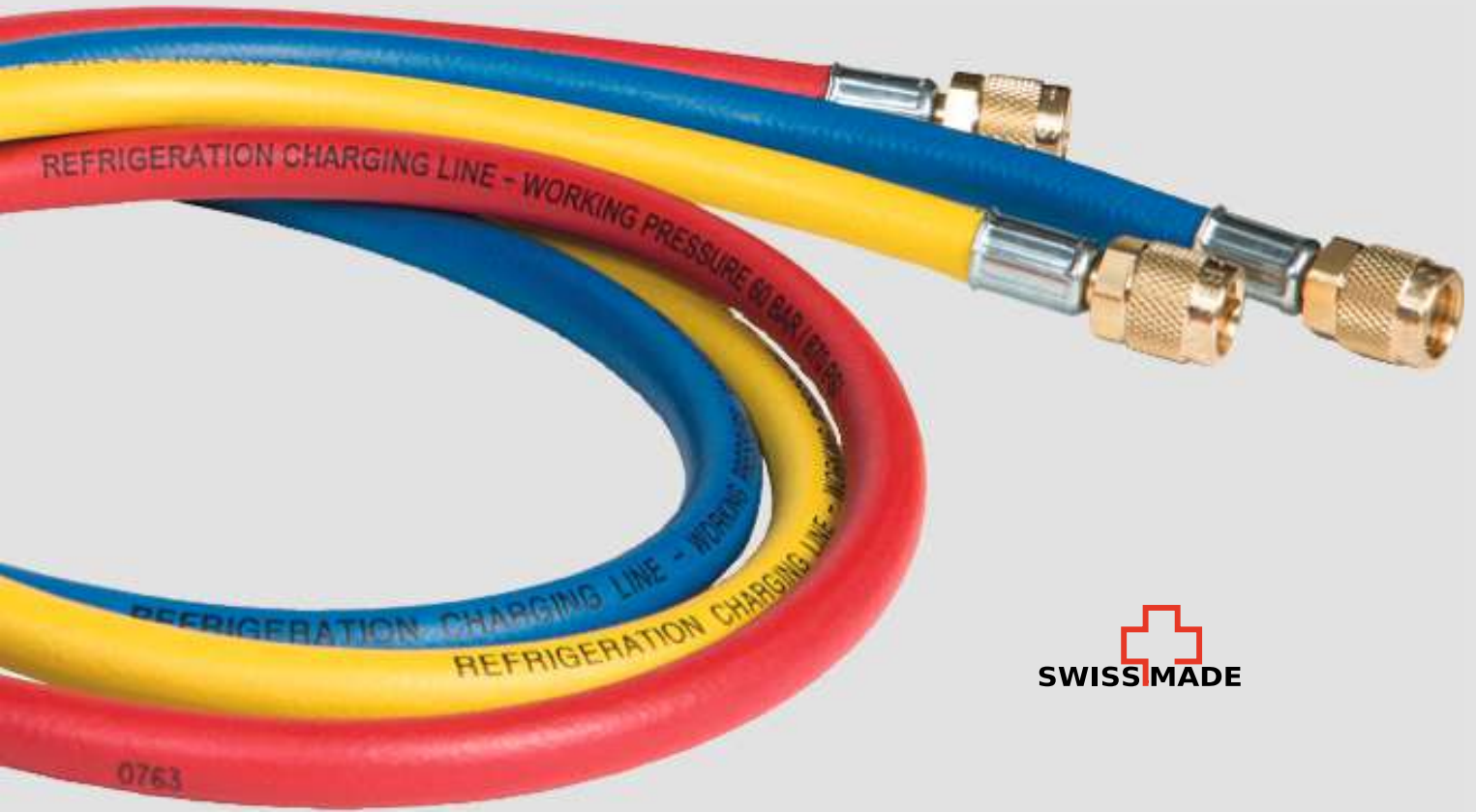

QC-S410A/2
与核心减压器的接合器，
1/4" SAE x 1/2 英寸-20 UNF。
部件号 4687095

QC-S410A/2
Adapter with core depressor,
1/4" SAE x 1/2"-20 UNF, 2 pcs.
Part No 4687095



CA-1/2"-20UNF-45°
球阀配备1/2 英寸-20 UNF高压
及低压接头，45° 连接核心减压。

CA-1/2"-20UNF-45°
Ball valve with a male and female connection
1/2"-20 UNF, 45° connection with
core depressor.

名称
Designation

部件号
Part No

CA-1/2"-20 UNF-B-45°	蓝色	blue	4682420
CA-1/2"-20 UNF-R-45°	红色	red	4682438
CA-1/2"-20 UNF-Y-45°	黄色	yellow	4682446

复式接头 - Manifolds



APEX-8

复式接头及Bourdon式仪表，挂钩，
无附件，包装于纸箱中。

APEX-6

复式接头及布顿式仪表，挂钩，三条编号充
气线接头1/4英寸 SAE，蓝色、红色及黄色，
长度36英寸（90厘米）， 包装于纸箱中。

APEX-3

配有布顿式仪表，挂钩，三条编号充气线接
头1/4英寸 SAE，蓝色、红色及黄色，长度
36英寸（90厘米），包装于坚固的塑料箱中。

APEX-8

Manifold with Bourdon type gauges, hook,
without accessories, packed in cardboard box.

APEX-6

with Bourdon type gauges, hook, 3 charging
lines 1/4" SAE blue, red and yellow, length
36 inches (90 cm), packed in cardboard box.

APEX-3

Manifold with Bourdon type gauges, hook,
charging lines 1/4" SAE blue, red and yellow,
length 36 inches (90 cm), in a sturdy plastic
case.

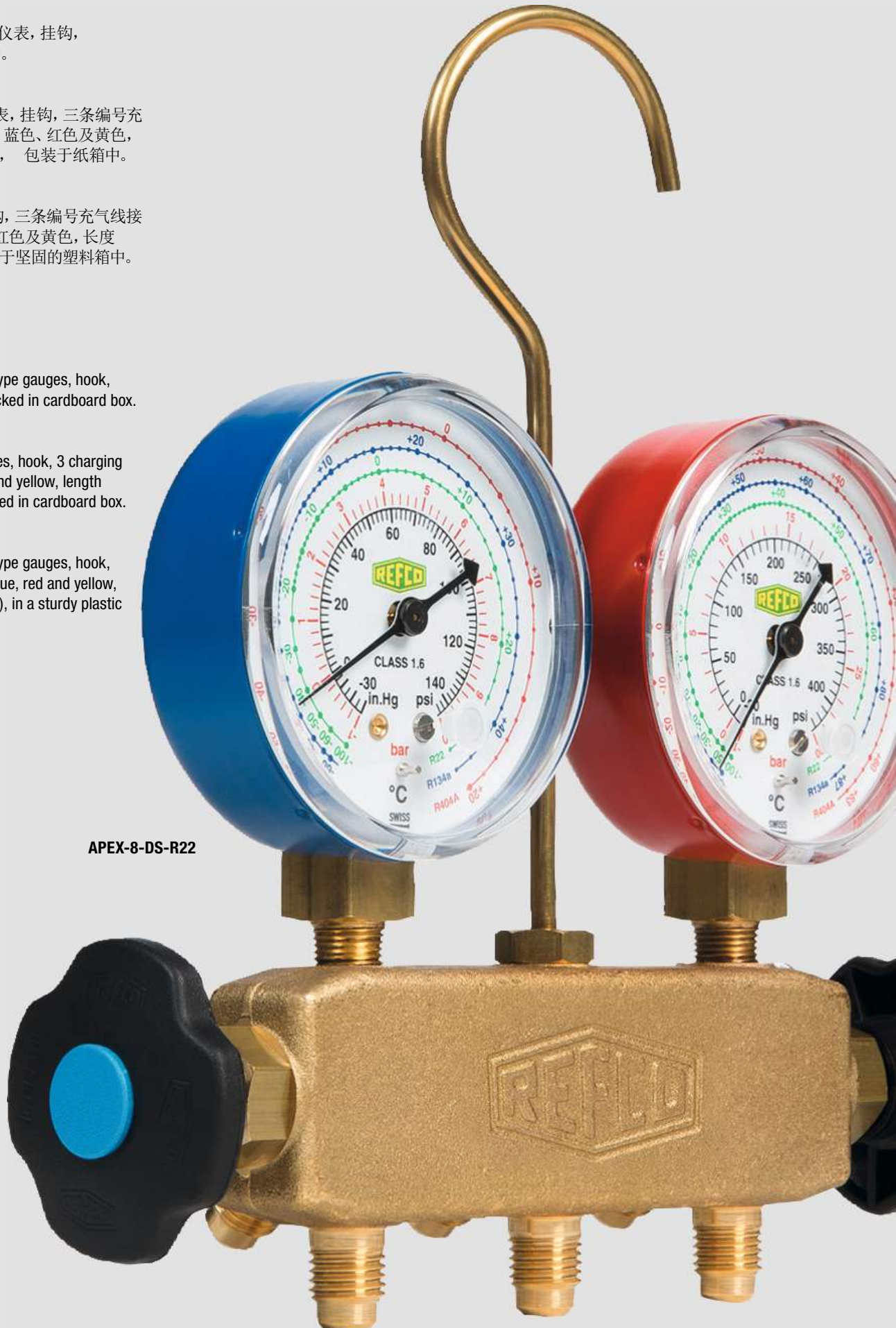

APEX-8-DS-R22



APEX-8



名称 Designation	部件号 Part No
APEX-8-DS-R134a	4667277
APEX-8-DS-R22	4686903

名称 Designation	部件号 Part No
APEX-6-DS-R134a	4667294
APEX-6-DS-R22	4684296

名称 Designation	部件号 Part No
APEX-3-DS-R134a	4667561

复式接头 - Manifolds



双向复式接头 - Two-way Manifolds

标准双向复式接头 配有透视玻璃
高质量铝制本体配有透视玻璃

BM2-8
布顿式计量表, 挂钩,
无附件, 包装于纸箱中。

BM2-6
配有布顿式仪表, 挂钩, 三条编号充气线
接头1/4英寸 SAE, 蓝色、红色及黄色,
长度36英寸 (90厘米), 包装于纸箱中。

BM2-3
配有布顿式仪表, 挂钩, 三条编号充气线
接头1/4英寸 SAE, 蓝色、红色及黄色, 长度
36英寸(90厘米), 包装于坚固的塑料箱
中。

BM2-3-Auto-Set
包括:
1件BM2-8-R-134a 复式接头
1件CL-72-B 蓝色充气线
1件CL-72-R 红色充气线
1件CL-72-Y 黄色充气线
1件CX-Auto-B-1/4" SAE 低压阀
1件CX-Auto-R-1/4" SAE 高压阀
1件M4-6-15 塑料箱

Two-way standard manifold with sight glass
High quality aluminium body with sight glass

BM2-8
Bourdon type gauges, hook, without
accessories, packed in a cardboard box.

BM2-6
with Bourdon type gauges, hook, 3 charging
lines 1/4" SAE blue, red and yellow, length
36 inches (90 cm), packed in a cardboard box.

BM2-3
with Bourdon type gauges, hook, 3 charging
lines 1/4" SAE blue, red and yellow, length
36 inches (90 cm), in a sturdy plastic case.

BM2-3-Auto-Set
consisting of:
1 pc BM2-8-R134a manifold
1 pc CL-72-B blue charging line
1 pc CL-72-R red charging line
1 pc CL-72-Y yellow charging line
1 pc CX-Auto-B-1/4" SAE low pressure
valve blue
1 pc CX-Auto-R-1/4" SAE high pressure
valve red
1 pc M4-6-15 plastic case



BM2-8-DS

名称 Designation	部件号 Part No
BM2-8-DS-R134a	9883336
BM2-8-DS-R470C	4503503
BM2-8-M-R22-R134a	9884895
BM2-8-DS-R22	9884896
BM2-8-DS-R290	4687381
BM2-6-DS-R134a	9882142
BM2-6-DS-R407C	4503520
BM2-6-M-R22-R134a	9884897
BM2-6-DS-R22	9884898
BM2-6-DS-R290	4687380
BM2-3-DS-R134a	9882140
BM2-3-DS-R407C	4503546
BM2-3-DS-R22	9884900
BM2-3-DS-R290	4687382
BM2-3-Auto-Set-DS	9883395
BM2-3-Auto-SET-DS-RC-R1234yf	4687046

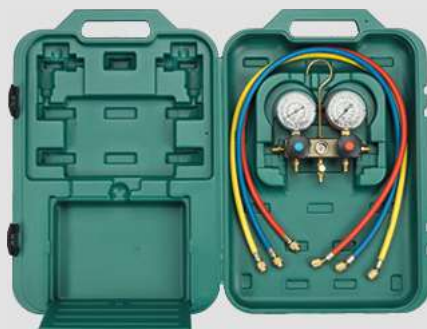

BM2-3-DS

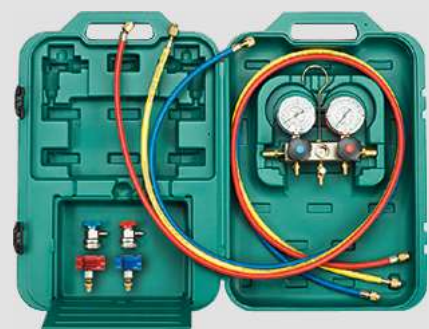

BM2-3-AUTO-SET-DS-RC-R1234yf

Two-way manifold with bellow type gauge

This series of manifolds is equipped with sight glass and bellow type gauges class 1. The oil-filled gauges are made of anodized aluminium, standard bellow type gauges are made of plastic.

M2-8

with standard bellow type gauges, hook, without accessories, packed in a cardboard box.

M2-6

with standard bellow type gauges, hook, 3 charging lines 1/4" SAE blue, red and yellow, length 36 inches (90 cm), packed in a cardboard box.

M2-3

with standard bellow type gauges, hook, 3 charging lines 1/4" SAE blue, red and yellow, length 36 inches (90 cm), in a sturdy plastic case.

M2-3-DELUXE

with oilfilled bellow type gauges, hook, 3 charging lines 1/4" SAE blue, red and yellow, length 36 inches (90 cm), in a sturdy plastic case.

双向复式接头配有波纹管式计量表

本系列复式接头配备透视玻璃和波纹管式1级计量表。注油计量表为经阳极化处理的铝制品，标准波纹管式计量表为塑料制品。

M2-8

配有装标于准纸波箱纹中管.式计量表, 挂钩, 无附件, 包装于纸箱中。

M2-6

配有布顿式仪表, 挂钩, 三条编号充气线接头1/4英寸 SAE, 蓝色、红色及黄色, 长度36英寸 (90厘米), 包装于纸箱中。

M2-3

配有布顿式仪表, 挂钩, 三条编号充气线接头1/4英寸 SAE, 蓝色、红色及黄色, 长度36英寸(90厘米), 包装于坚固的塑料箱中。

M2-3-DELUXE

配有注油波纹管式仪表, 挂钩, 三条编号充气线接头1/4英寸 SAE, 蓝色、红色及黄色, 长度36英寸(90厘米), 包装于坚圆的塑料箱中。



M2-6-DS

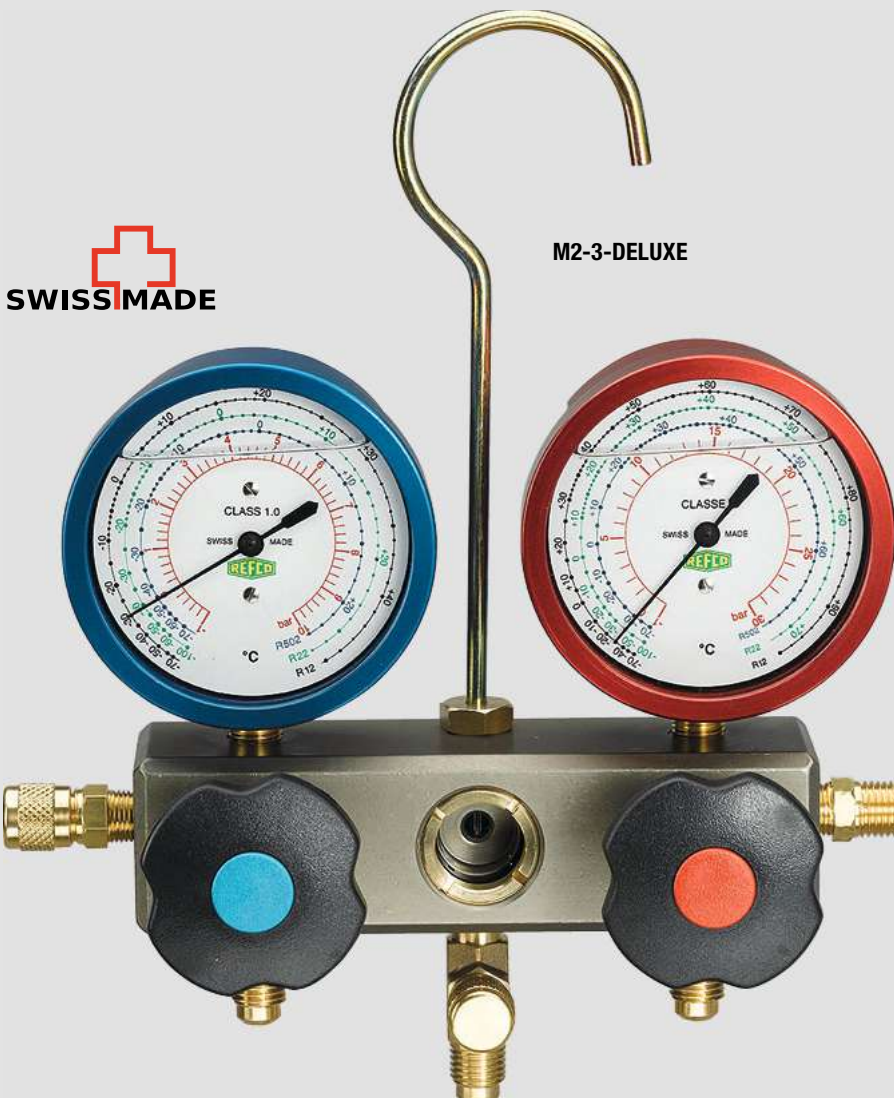

SWISS MADE

M2-3-DELUXE

名称
Designation

部件号
Part No

M2-8-DS-R12-N	9882555
M2-8-DS-R134a	9883768
M2-8-M-R22	9884998
M2-8-DS-R22	9884391
M2-6-DS-R12-N	9883769
M2-6-M-R134a	9883770
M2-6-DS-R134a	9883771
M2-6-M-R22	9884999
M2-6-DS-R22	9884390
M2-6-M-R407C	9884245
M2-3-M-R12-N	9885035
M2-3-DS-R12	9882564
M2-3-M-R134a	9883550
M2-3-DS-R134a	9883354
M2-3-M-R22	4493754
M2-3-DS-R22	9884355
M2-3-M-R407C	9883986
M2-3-DELUXE-M-R12-N	9885034
M2-3-DELUXE-DS-R12	9882552
M2-3-DELUXE-M-R134a	9883511
M2-3-DELUXE-DS-R134a	9883722
M2-3-DELUXE-M-R22	9884977
M2-3-DELUXE-DS-R22	9884392
M2-3-DELUXE-M-R407C	9883368
M2-3-DELUXE-M-R290	9883731
M2-3-DELUXE-DS-R744	4682641

复式接头 - Manifolds



双向复式接头 - Two-way Manifolds

JUMBO-STAR

双向复式接头高密度铜件配备透视镜。

大号 $\frac{3}{8}$ 英寸内径及 $\frac{3}{8}$ 英寸接头。

JUMBO-STAR-2-6

配备布顿型计量表, 挂钩、三条充气线
 $\frac{3}{8}$ 英寸 SAE蓝色、红色和黄色, 长度
36英寸(90厘米), 包装于纸板箱中。

JUMBO-STAR

Two way manifolds compact brass body with sight glass.

With large $\frac{3}{8}$ " bores and $\frac{3}{8}$ " connections.

JUMBO-STAR-2-6

with Bourdon type gauges, hook, 3 charging lines $\frac{3}{8}$ " SAE blue, red and yellow, leng 36 inches (90 cm), packed in a cardboard box.

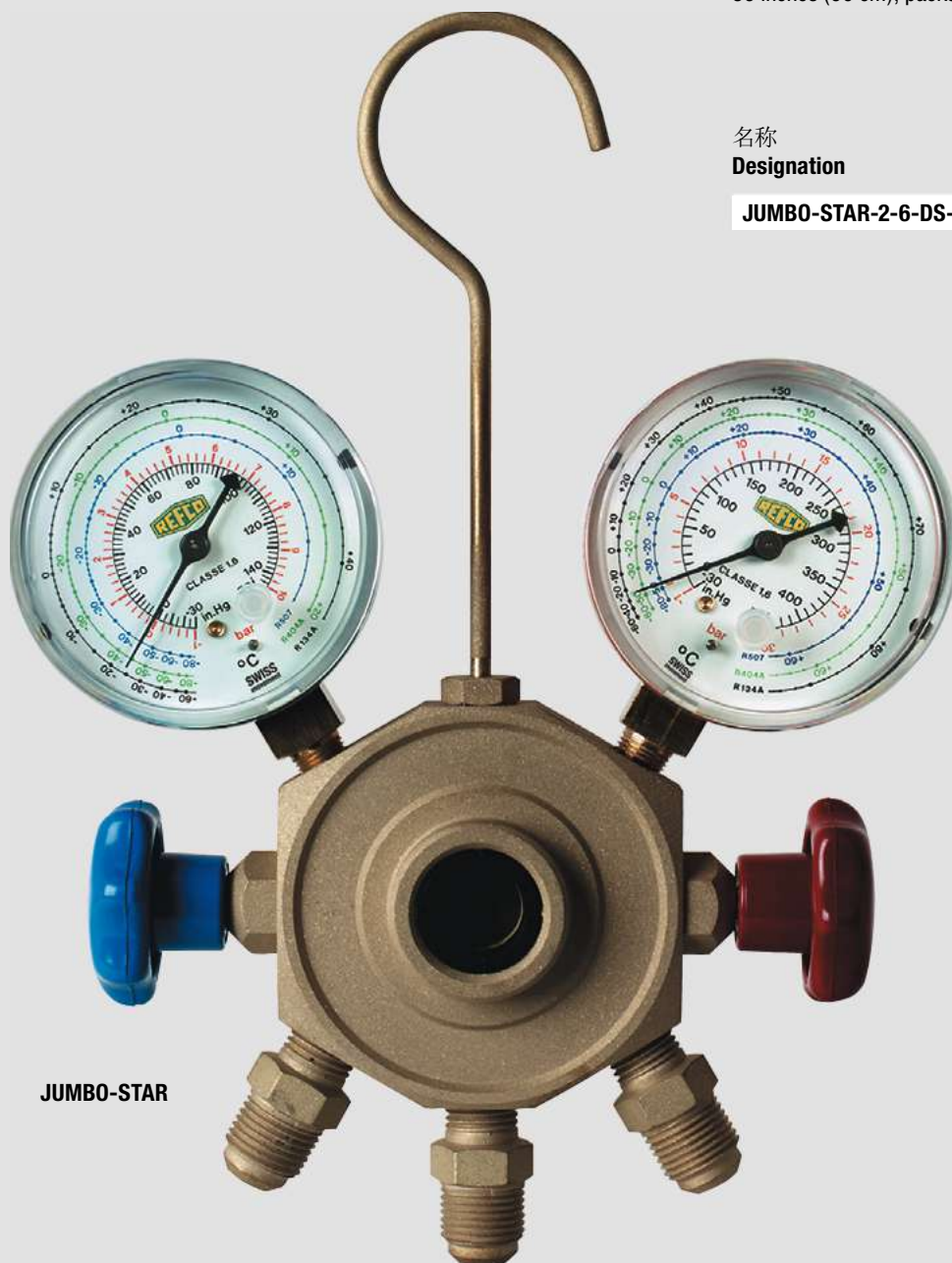

名称
Designation

部件号
Part No

JUMBO-STAR-2-6-DS-R134a

4493860

JUMBO-STAR

双向复式接头SUPER-LUXE

杰出的设计和技术:

- 高质量铝制品
- 波纹管式计量表1.0级

MK-2-3 SUPER LUXE

配有注泊波纹管式仪表, 挂钩, 三条编号充气线接头1/4英寸SAE, 蓝色、红色及黄色, 长度60英寸(150厘米), 包装于坚圆的塑料箱中。

Two-way manifold SUPER-LUXE

The master piece in design and technology:

- body made of high quality eloxed aluminium
- bellow type gauges class 1.0

MK-2-3 SUPER LUXE

with oilfilled bellow type gauges, hook, 3 charging lines 1/4" SAE blue, red and yellow, length 60 inches (150 cm), in a sturdy plastic case.



MK-2-3 SUPER LUXE

名称

Designation

部件号

Part No

MK-2-3-DS-R12

9883536

MK-2-3-DS-R134a

9882592

MK-2-3-M-R407C

9882589

复式接头 - Manifolds

单向和双向复式接头备件 - Four-way Manifolds

四向复式接头，布顿式计量表及透视玻璃。

BM4-3

配有布顿式仪表，挂钩，三条编号充气线接头1/4英寸SAE，蓝色、红色及黄色，长度36英寸(90厘米)，包装于坚固的塑料箱中。

Four-way manifold with Bourdon type gauges and sight glass

BM4-3

with Bourdon type gauges, hook, 3 charging lines 1/4" SAE blue, red and yellow, length 36 inches (90 cm), in a sturdy plastic case.



BM4-3-DS

名称 Designation	部件号 Part No
BM4-3-DS-R134a	9883808
BM4-3-DS-R407a	4503414
BM4-3-M-R22-R134a	9884915
BM4-3-DS-R22	9884916

M2-7-SET-B+R

手轮蓝色和红色
部件号 4687079

M4-7-SET-B+N+R+Y

手轮蓝色，黑色，红色，黄色
部件号 4687094

M2-7-SET-B+R

handwheel blue and red
Part No 4687079

M2-7-SET-B+N+R+Y

handwheel blue, black, red, yellow
Part No 4687094



M2-7-SET

M4-7-SET

M2-10-95/4
全套阀门组, 4枚
部件号 **4687100**

M2-10-95/4
complete valve set, 4 pcs.
Part No 4687100



M2-10-95

M4-6-04/10
活塞及垫圈, 10枚
部件号 **9884161**

M4-6-04/10
piston including gaskets, 10 pcs.
Part No 9884161



M4-6-04

M4-6-11
包括适视玻璃, 胶圈及螺丝铜环
部件号 **4491018**

M4-6-11
Assembly of sight glass, gaskets and threaded
brass ring
Part No 4491018

M4-6-11-T
复式接头销匙
透视镜
部件号 **4493169**

M4-6-11-T
key for manifold sight glass
Part No 4493169

M4-6-14
塑料箱
内有橡皮泡沫
部件号 **4678431**

M4-6-14
plastic case with rubber foam inset
Part No 4678431

M4-6-15
多用途胶盒,
可用于双向及四通表组
部件号 **4666106**

M4-6-15
plastic case to fit the various 2-way and 4-way
REFCO manifolds
Part No 4666106



M4-6-11-T



M4-6-11



M4-6-14



M4-6-15

充气线 - Charging Hoses

充气线1/4英寸 SAE - Charging Hoses 1/4" SAE

REFCO-软管1/4英寸 SAE

[威科]软管与特氟隆垫圈一同提供。与普通橡胶相比特氟隆垫圈的使用寿命至少长10倍以上。软管的倒钩和特氟隆垫圈装置有新发明的快速嵌入器系统可防止掉出软管。

高质线，
适用于所有制冷剂，工作压力为
60巴/870每平方英寸，爆破压力300巴/
4350磅 每套3条，蓝色、红色和黄色。

REFCO-Hoses 1/4" SAE

REFCO-hoses are supplied with PTFE-gaskets. The lifetime of PTFE-gasket compared to ordinary rubber is at least 10 times longer. The barb of the hose, as well as the PTFE-gasket have been equipped with a new invented quick-snapper system to prevent falling out of the hose.

High Quality hoses suitable for all Refrigerants, working pressure 60 bar/870 psi, Burst pressure 300 bar/4350 psi, set of 3 lines, 1 unit each blue, red and yellow.

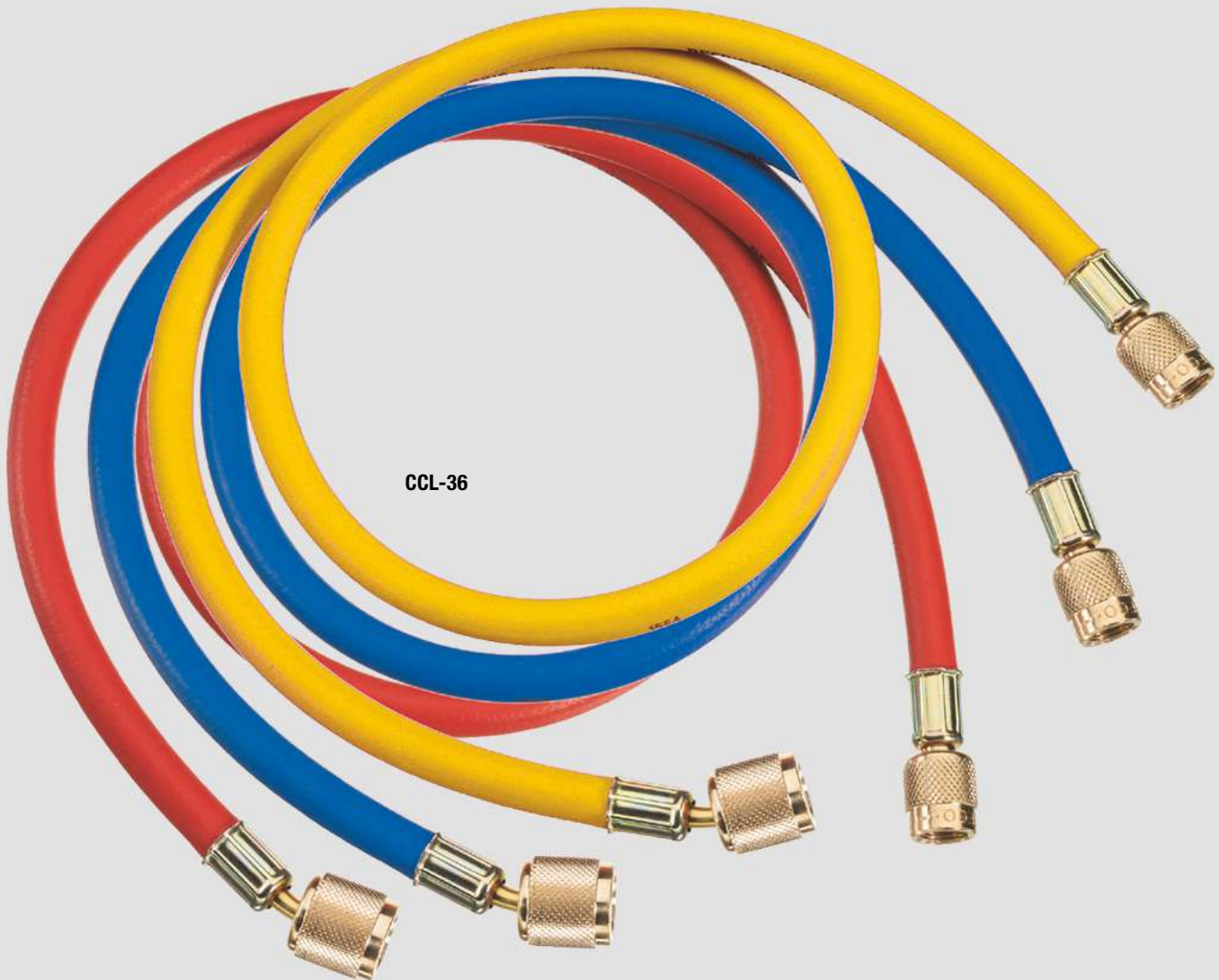



每套三条
Set of 3 pcs.

名称 Designation	长度英寸 Length inches	长度厘米 Length cm	部件号 Part No
CCL-36	36	90	9881278
CCL-48	48	120	9881277
CCL-60	60	150	9881276
CCL-72	72	180	9881275

单条充气线
Single Charging Hoses

名称 Designation	长度英寸 Length inches	长度厘米 Length cm	部件号 Part No		
			B	R	Y
CL-6	6	15	9881256	9881265	9881274
CL-12	12	30	9881255	9881264	9881273
CL-24	24	60	9881254	9881263	9881272
CL-36	36	90	9881253	9881262	9881271
CL-48	48	120	9881252	9881261	9881270
CL-60	60	150	9881251	9881260	9881269
CL-72	72	180	9881250	9881259	9881268
CL-120	120	300	9881249	9881258	9881267
CL-144	144	365	9881247	9881257	9881266

商强度线 $\frac{3}{8}$ 英寸 SAE
大直径高强度线
建议作为所有制冷剂的永久性部件
软管 $\frac{3}{8}$ 英寸, 以O形环连接。

Heavy-Duty-Hoses $\frac{3}{8}$ " SAE
Large Diameter Heavy Duty Lines.
Recommended as permanent part for all
refrigerants.
Hose $\frac{3}{8}$ ", connection with O-Ring.

名称 Designation	长度英寸 Length inches	长度厘米 Length cm	部件号 Part No		
			B	R	Y
HCL6-36	36	90	9881310	9881320	9881315
HCL6-48	48	120	9881309	9881319	9881314
HCL6-60	60	150	9881308	9881318	9881313
HCL6-72	72	180	9881307	9881317	9881312
HCL6-144	144	365	9881306	9881316	9881311



订货时请说明所需颜色:
B为蓝色, R为红色, Y为黄色

When ordering specify colour requested:
B=Blue, R=Red, Y=Yellow



充气线 - Charging Hoses

充气线备件 - Spare Parts for Charging Hoses

P-510/10

O-型环垫圈用于
3/8英寸 SAE 充气线,
10枚
部件号 **9880870**

P-510/10

O-Ring Gasket for
3/8" SAE charging lines,
10 pcs.
Part No **9880870**



P-510

A-40513/10

压缩器用于
3/8英寸强度线,
10枚
部件号 **9884813**

A-40513/10

Depressor for
3/8" heavy duty lines,
10 pcs.
Part No **9884813**



A-40513

P-509/10

所有REFCO充电注
管垫片是氯丁橡胶
黑色10个
部件号 **9880872**

P-509/10

Neoprene gasket,
10 pcs. black, for all
REFCO charging hoses
Part No **9880872**

备件, 接头

Spare Parts, Connections

P-509/100

同上, 100枚
部件号 **9883980**

P-509/100

as above, 100 pcs.
Part No **9883980**

CPV-250-E-1/4" SAE

魔术线弯接头及
内置阀门
部件号 **9881226**

CPV-250-E-1/4" SAE

Elbow connector for magic
line with built-in valve
Part No **9881226**



CPV-250-E-1/4" SAE

CPV-250-S-1/4" SAE

P-509-T/10

特氟龙(teflon)白色,
10个, 可供所有威科
充注管使用
部件号 **9880871**

P-509-T/10

PTFE gasket, 10 pcs.
white, for all REFCO
charging hoses
Part No **9880871**

CPV-250-S-1/4" SAE

魔术线直接头及
内阀门
部件号 **9881225**

CPV-250-S-1/4" SAE

Straight connector for magic
line with built-in valve
Part No **9881225**

P-509-T/100

同上, 100枚
部件号 **9883979**

P-509-T/100

as above, 100 pcs.
Part No **9883979**

CL-SC-1/4" SAE

用于普通1/4英寸
SAE 充气线的直接头,
包括螺母、
倒钩及垫圈
部件号 **9881224**

CL-SC-1/4" SAE

Straight connector for
normal 1/4" SAE
charging line consists
of nut, barb and gasket
Part No **9881224**

P-513/10

施瑞德阀压缩器,
10枚
部件号 **9880869**

P-513/10

Depressor for Schrader-
valves, 10 pcs.
Part No **9880869**

CL-ECD-1/4" SAE

用于普通1/4英寸
SAE 充气
倒线的弯接缓冲头冲,
包括螺母、钩、
器及垫圈
部件号 **9881223**

CL-ECD-1/4" SAE

Elbow connector for
normal 1/4" SAE
charging line consists
of nut, barb,
depressor and gasket
Part No **9881223**



CL-ECD-1/4" SAE



CL-SC-1/4" SAE

P-513/100

同上, 100枚
部件号 **9883961**

P-513/100

as above, 100 pcs.
Part No **9883961**

V-35010/5

直耦合器, 5枚
部件号 **9884825**

V-35010/5

Straight Coupler, 5 pcs.
Part No **9884825**



P-509



P-509-T

V-35012/5

弯耦合器, 5枚
部件号 **9884826**

V-35012/5

Elbow Coupler, 10 pcs.
Part No **9884826**



V-35012

V-35410/5

直形接头用于410A,
5枚
部件号 **4666336**

V-35410/5

Straight Coupler for R410A,
5 pcs.
Part No **4666336**

V-35412/5

角形接头用于R410A,
5枚
部件号 **4666344**

V-35412/5

Elbow Coupler for R410A
5 pcs.
Part No **4666344**



V-35010



P-513

CA-2-B

无附件阀, 蓝色
两端内径均为1/8英寸
部件号 **4492804**

CA-2-R

无附件阀, 红色
两端内径均为1/8英寸
部件号 **4492791**

CA-2-Y

无附件阀, 黄色
两端内径均为1/8英寸
部件号 **4492812**



CA-2-R



CA-1/4" SAE-Y



CA-1/4" SAE-45°

CA-2-B

Valve without accessories, blue
I.D. 1/8" G both sides
Part No **4492804**

CA-2-R

Valve without accessories, red
I.D. 1/8" G both sides
Part No **4492791**

CA-2-Y

Valve without accessories, yellow
I.D. 1/8" G both sides
Part No **4492812**

CA-1/4"SAE-B

与充气软管连接的阀, 外径为1/4英寸SAE, 内径为1/4英寸SAE, 配备可松动螺母和核心压器, 蓝色
部件号 **4493525**

CA-1/4"SAE-R

与充气软管连接的阀, 外径为1/4英寸SAE, 内径为1/4英寸SAE, 配备可松动螺母和核心压器, 红色
部件号 **4493533**

CA-1/4"SAE-Y

与充气软管连接的阀, 外径为1/4英寸SAE, 内径为1/4英寸SAE, 配备可松动螺母和核心压器, 黄色
部件号 **4493738**

CA-1/4" SAE-45°

与充气软管连接的阀, 阳性接头为1/4英寸SAE, 阴性接头为1/4英寸SAE 配备可松动螺母和核, 己、压器

CA-1/4" SAE-B

Valve in connection with charging hoses. O.D. 1/4" SAE. I.D. 1/4" SAE with loose nut and core depressor, blue
Part No **4493525**

CA-1/4" SAE-R

Valve in connection with charging hoses. O.D. 1/4" SAE. I.D. 1/4" SAE with loose nut and core depressor, red
Part No **4493533**

CA-1/4" SAE-Y

Valve in connection with charging hoses. O.D. 1/4" SAE. I.D. 1/4" SAE with loose nut and core depressor, yellow
Part No **4493738**

CA-1/4" SAE-45°

Valve in connection with charging hoses, male connection 1/4" SAE, female connection 1/4" SAE, 45° connection with loose nut and core depressor

名称

Designation

部件号

Part No

CA-1/4" SAE-B-45°	蓝色	blue	4682390
CA-1/4" SAE-R-45°	红色	red	4682404
CA-1/4" SAE-Y-45°	黄色	yellow	4682412

CA-2x1/4"SAE-Y-N-OD-45°

球阀连2个内螺母活动口1/4" SAE, 45°, 和氯丁橡胶垫片连接
部件号 **4687052**

CA-2x1/4"SAE-Y-N-OD-45°

Ball valve with 2 female connections 1/4" SAE, 45° connection with loose nut and neoprene gaskets
Part No **4687052**

单条充气线

Single Line Charging

名称

Designation

长度英寸

Length inches

长度厘米

Length cm

部件号

Part No

B

R

Y

CA-CL-36	36	90	4492910	4492928	4492936
CA-CL-60	60	150	4492944	4492952	4492961
CA-CL-72	72	180	4492979	4492987	4492995

配CA阀软管, 每套一条

Hoses with CA valves, Set of 3 pcs.

名称

Designation

长度英寸

Length inches

长度厘米

Length cm

部件号

Part No

CCL-36-CA	36	90	4668559
CCL-60-CA	60	150	4668533
CCL-72-CA	72	180	4675521



CCL-36-CA

冷媒泄漏探测器 - Leak Detection

电子冷媒测漏器 - Electronic Leak Detectors

REF-LOCATOR

测漏仪的要求不断增加，就以上最新的发展和新技术，我们已经开发REF-LOCATOR 电子冷媒测漏器能满足专业规范和所有冷媒气体需求的准确探测器，在加热电解质传感器技术的基础上，树立新的标准。该传感器具有高于平均水平约10年的生命周期，相比传统的测漏仪有更大的优势。通过调整的灵敏度水平，容易快速地寻找泄漏的位置。此外，检查灯在黑暗中使用更理想。

REF-LOCATOR

The requirements for leak detectors are constantly increasing and in order to keep up with the newest developments and technologies, we have developed the REF-LOCATOR. This high-end unit fulfills all the norms and requirements which are expected from a modern leak detector today. The basis of solid electrolyte sensor technology sets new standards in the area of leak detection. The sensor has a higher than average life cycle of approximately 10 years, which is a large advantage over conventional leak detectors. With the large LCD display, one is always informed about the ongoing activities. Through the adjustment of the 3 sensitivity levels, it is easy to localize large leakages. In addition, the inspection light is ideal for having a good overview, even in the dark. The REF-LOCATOR is delivered in a practical, rugged case.

软件数据:

灵敏度: 1.4克/年所有的HFC的包括 R410A, R404A, R407C和 R134a

0.7 克/年HCFC R22,
0.9克/年 HFOR-123yf

标准: SAEJ2791 (R-134a),
SAEJ2913 (R-1234yf)

认证: SAE-J2791, SAE-J2913
EN14624:2012, CE, ROHS,
ASHRAE Standard 173

检测灯: 3个白色LED指示灯及3UV-
5分钟后关闭

传感器 寿命: >10年/4000小时

传感器 技术: 固体电解质半导体

热身时间: 约30秒

反应时间: 即时

显示: BTN-LCD显示屏带10段色
圆形图作显示泄漏的大小

灵敏度 等级: 3级:高- 4克/年
中- 7克/年
低-14克/年

静音功能: 静音模式下显示泄漏情况

电源: 4节AA碱性或4节AA镍氢电池

电池寿命: 4小时

防水认证: IP54

探头长度: 43 厘米

外形尺寸: 250x75x65 毫米

重量: 550 克

部件号 4686714

Technical Data:

Sensitivity: 1.4 g/year all HFC's incl.R410A,
R404A, R407C & R134a

0.7 g/year HCFC R22,
0.9g/year HFO R-123yf

Standards: SAEJ2791 (R-134a),
SAEJ2913 (R-1234yf)

Certifications: Compiles to standard
SAE-J2791, SAE-J2913
EN14624:2012, CE, ROHS,
ASHRAE Standard 173

Inspection light: 3 white LED's and 3 UV -
auto shut-off after 5 minutes

Sensor life: > 10 years/4000 hours

Sensor

Technology: Solid electrolyte semi-conductor

Warm-up time: approx. 30 seconds

Response time: instantaneous

Display: BTN-LCD with 10 segment
color "pie graph" showing
leak size

Sensitivity levels: 3 levels: MAX-4 g/yr
MED-7g/yr
Min-14g/yr

Mute function: Silent mode - Display shows
leak indication visually

Power supply: 4 AA Alkaline or 4 AA NiMH
Batteries

Battery life: 4 hours

IP-classification: 54

Probe length: 43 cm

Dimensions: 250x75x65 mm

Weight: 550 g

Part No 4686714



REF-LOCATOR



NEW



新的UV及LED灯能帮助寻找冷媒泄漏位置，而无需要配带UV眼镜

New with both UV and LED lights to help find refrigerant leaks! No UV-enhancement glassed needed

備件及配件供
REF-LOCATOR

Spare Parts and
Accessories for
REF-LOCATOR

REF-LOCATOR-CASE
手提箱
部件号 4686707

REF-LOCATOR-CASE
Carrying case
Part No 4686707

REF-LOCATOR-SEN-01
可更换的探测头
部件号 4686822

REF-LOCATOR-SEN-01
Replacement sensor
Part No 4686822

REF-LOCATOR-TV-01
测试液
部件号 4686705

REF-LOCATOR-TV-01
Test vial
Part No 4686705

LOCATOR-FILTER/5
备用过滤器5个
部件号 4686821

LOCATOR-FILTER/5
Spare filter, 5 pcs.
Part No 4686821

LOCATOR-LED-UV/6
备用LED UV 灯 6个
部件号 4687034

LOCATOR-LED-UV/6
Spare LED UV, 6 pcs.
Part No 4687034

LOCATOR-LED-WHTE/6
备用LED 白色灯 6个
部件号 4686828

LOCATOR-LED-WHTE/6
Spare LED white, 6 pcs.
Part No 4686828



REF-LOCATOR-CASE



REF-LOCATOR-SEN-01



REF-LOCATOR-TV-01

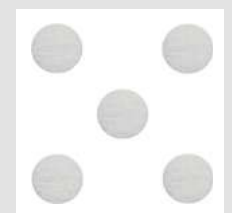

LOCATOR-FILTER/5



LOCATOR-LED-UV/6



LOCATOR-LED-WHTE/6

泄漏探测 - Leak Detection

电子泄漏探测器适用于所有卤化制冷剂 - Electronic Leak Detectors for all Halogenated Refrigerants

Startek

- 产品采用蜂巢结构式设计
 - 精确度比一般泄漏探测仪准确度极高
 - 寻找泄漏目标焦点最接近
 - 能用全部冷煤, 包括所有环保冷煤等
 - 产品标准SAE J1627认可
 - 按钮开关操作简单
 - 按钮式重组键
- 高效能而准确的机械式抽气能提供正确气流至感应器尖端不但能提供渐变式而可听见的频率而且还有视觉上的信号若在长时间不用状态下系统会自动关闭以保护电池寿命
- 电池寿命指示器当电池不够能源时会发出警报讯号几声响, 为避免错误数据读出系统会自动关机此人感应捺技术是属于高度可靠性及延长寿命形式
- 内含一个实用皮夹子套来保护工具箱内的检漏议
- 特别设计12英寸(30公分)探测器能容易地伸展到所需范围
 - 附加感应器探测头在电池分隔栏内

技术数据:

体积: 150x34x55 毫米
重量: 190克
电池: 2xAA电池
电池使用: 40小时
精准度: 3克/每年 (0.1 安士/每年)
感应器: 能用30小时

温度: 0-50度(摄氏)
标准时间: 最小测2次
反应时间: 实时
重复时间: 实时
准确度: 30厘米
部件号 **4507569**

ES-02

反备感应头(2个包装)
部件号 **4507577**



STARTEK

- extremely compact design concept similar to a cell phone
- ergonometical design focused on performance and simplicity of operation
- Microprocessor controlled unit and state of the art microelectronics
- Detects all halogenated refrigerants
- Certified to SAE J1627 standard
- Simple one-button operation
- Two sensitivity levels using a doubleclick computer mouse action
- One touch reset-mode
- High performance true mechanical Pump to provide positive airflow through the sensing tip
- Leak indication using both variable frequency audible and visual alarm
- Automatic shut-off after extended period of non-use to preserve battery life
- Battery life indicator
- Prevents incorrect readings by providing visual and audible warning followed by an automating shut-off when battery reaches a critical level
- State of the art sensor technology for higher reliability longer life time
- Includes a practical belt clip holster that also protects the unit in your tool box
- Specialiy designed 12" (30 cm) flexible probe for easy reach
- Additional replacement sensor included inside the battery compartment
- In a sturdy plastic case

Technical Data:

Dimensions: 150x34x55 mm
Weight: 190 g
Batteries: 2 x AA batteries
Battery lifetime: 40 hours
Sensitivity: less than 3g/year (0.1oz/year)
Sensor lifetime: approx.30 hours
Operating temperature: 0-50 °C
Warm-up time: less than 2 seconds
Response time: instantaneous
Reset time: instantaneous
Probe Length: 30 cm
Part No 4507569

ES-02

Replacement sensor (Pack of 2)
Part No 4507577



STARTEK

STARTEK

STARTEK-C

最新敏感型气体检漏仪，低电量要求，轻巧，高敏感度结合工具，易于操作更能有效地感应溴漏来源，此型各有长寿命感应头集中感应可燃气体低至5ppm，内置高效能而准确机械式抽气泵，能提供正确气流至感觉器来端。此检漏仪，可检漏所有可燃气体，能够容易快速地寻找溴漏位置。
新款型号包装在坚固塑料箱内。

技术数据:

体积: 150x34x55 毫米
重量: 190克
电池: 2xAA电池
电池使用: 11小时
精确度: 少于50ppm (最佳电池)
感应器: 正常使用下少于1年
温度: 0-50度 (摄氏)
准备时间: 45秒
校对模式: 自动
反应时间: 5秒
重设时间: 5秒或以上, 取决于气体集中情况
探索器度: 30厘米
部件号 **4660664**

ES-C

探索头
部件号 **4660672**



STARTEK-C

STARTEK-C

The new combustible Gas Leak Detector in the new successful design is the most technologically advanced of its kind.

The STARTEK-C's low power requirements, small size and high sensitivity combine to create a tool which is easy to handle and ultra effective at locating even the most difficult-to-find leaks.

The STARTEK-C's long life sensor will detect concentrations of combustible gases as low as 5 ppm. It is sensitive to all combustible gases. The STARTEK-C also features a low sensitivity mode, enabling quick and easy location of large combustible gas leaks.

Supplied in a sturdy plastic case.

Technical Data:

Dimensions: 150x34x55 mm
Weight: 190 g
Batteries: 2 x AA batteries
Battery lifetime: 11 hours
Sensitivity: less than 50 ppm (Propane, Isobutan, Methane)
Sensor lifetime: less than 1 year normal use
Operating temperature: 0-50 °C
Warm-up time: 45 seconds (conditioned sensor)
Calibration: automatic
Response time: 5 seconds
Reset time: 5 seconds or more depending on gas concentration
Probe Length: 30 cm
Part No 4660664

ES-C

Replacement sensor
Part No 4660672

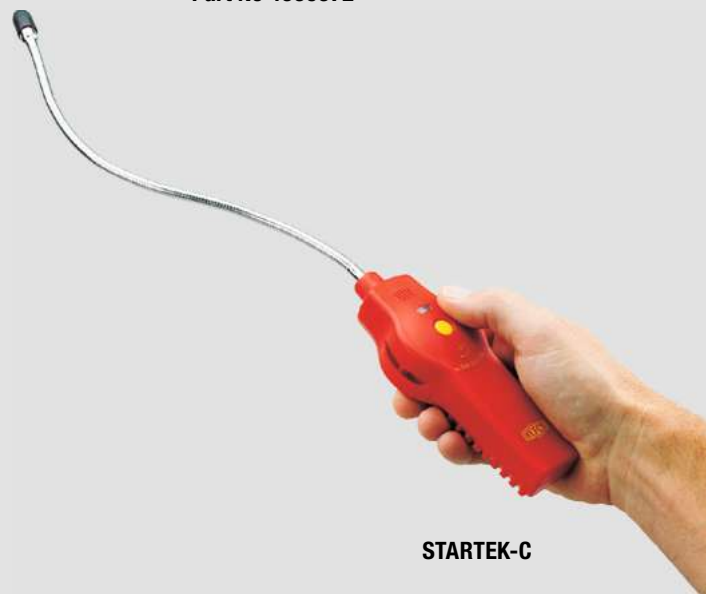

STARTEK-C

泄漏探测 - Leak Detection

紫外线泄漏探测器 - Ultra Violet Leak Detector

紫外线泄漏探测器

使用密集强力UV-12紫外线探照灯进行无懈可击的泄漏探测。UV-12既可以直接连接于车辆电池，亦可由任何随意携带的电池盒供电。这使得UV-12在汽车领域和一切其他冷冻和空调电器的应用中成为普及的UV探测器。

UV-12可发现电子探测器所无能为力的泄漏，如特小的泄漏，间断性泄漏和多发性泄漏等。

甚至是气体已泄漏殆尽的泄漏仍可测出，因为UV-12仍可显示荧光痕迹。

用注射枪对系统进行一次荧光注射便足够用于1.5公斤制次冷剂和300克压缩机油。

UV-12KIT

全套工具包装于坚固的塑料箱内，内有：

UV-探照灯12伏特/100瓦
供电使用的鳄鱼夹调节器
Glo-Gun注射系统
Glo-Gun再次充装盒
安全眼镜
带有自动耦合的软管
带有1/4英寸SAE接头的软管
部件号 **9884406**

UV-GLO-LEAK-C

再次充装盒，容量48毫升
部件号 **9884405**

UV-GLO-LEAK-250

荧光液，容量250毫升
部件号 **9884515**

UV-AKKU

12伏特电池盒，
包括220伏特充电器
部件号 **9884514**

Ultra Violet Leak Detector

The uncompromised way of leak detection with the compact and powerful UV-12 ultraviolet inspection lamp. UV-12 can either be connected directly on a vehicle battery or being powered by the optional go anywhere battery pack. This makes the UV-12 the universal UV detector in the automotive field as well as for all other refrigeration and air con applications.

UV-12 enables to find leaks where electronic leak detectors could be compromised, like extremely small leaks, intermittent leaks, multiple leaks. Even leaks where all the gas has already escaped can still be found as the UV-12 will still show the fluorescent trace.

One shot of fluorescent applied into a system with the practical injector gun is sufficient for 1.5 kg of refrigerant and up to 300 grams of compressor oil.

UV-12-KIT

Kit complete in sturdy plastic case
Content:

UV-Inspection lamp 12 Volt/100 W
Crocodile clip adapter for battery connection
Glo-Gun injector system
Glo-Gun refill cartridge
Safety spectacles
Hose assembly with automotive coupling
Hose assembly with 1/4" SAE connection
Part No 9884406

UV-GLO-LEAK-C

Glo-Leak refill cartridge, content 48 ml
Part No 9884405

UV-GLO-LEAK-250

Fluorescent liquid, content 250 ml
Part No 9884515

UV-AKKU

Battery pack 12 volt including charger 220 V
Part No 9884514



UV-12-KIT



UVA-10



UV-100-02



UV-GLO-LEAK-250



UV-GLO-LEAK-C



16840

16487

16840

卤化物泄漏探测器可快速准确地测定非可燃性和制冷剂的气体泄漏(R12, R22和R502)。泄漏可造成燃烧器内肉眼可见的颜色变化和火焰强度变化。

轻便、可携带并配有坚固的铜制泄漏探测器装配零件、探寻软管和可持续15小时的燃油罐。

部件号 **9881459**

16840

Halide leak detector locates non-combustible refrigerant gas leaks (R12, R22, R502) quickly and accurately. Leaks cause visible change of colour and intensity of flame housed in burner. Portable, lightweight, complete with solid brass leak detector assembly, search hose and fuel cylinder which lasts up to 15 hours.

Part No 9881459

16840-01

无罐卤化物泄漏探测器, 包括软管

部件号 **9881458**

16840-01

Halide leak detector without tank, including hose

Part No 9881458

16840-12

16840通气口

部件号 **9882121**

16840-12

Orifice for 16840

Part No 9882121

16847

丙烷单向气筒

部件号 **9881693**

16847

Propane one-way cartridge

Part No 9881693

16848/2

反应器底盘

部件号 **4687086**

16848/2

Reactor plate, 2 pcs.

Part No 4687086



16848

丙烷泄漏探测器

Leak Search-Spray

10620

检漏引射器

容量375克

10620

Leak shooter search-spray

contents 375 g



10620

检漏引射器是维修人员用来检验耐压管或系统中是否有泄漏。使用很方便, 只需用引射器将液体射向耐压系统, 有泄漏的位置立即会出现泡沫。

无危险

部件号 **9881420**

A real hit for any service man to shoot for leaks on pressurised tubes i.e. systems. Easy application; just spray strongly any pressurised lines with Leaky-Shooter. Bubbles will occur immediately on leaky systems.

No danger!

Part No 9881420

10621

黄色检漏泊贴, 将泊涂于表面。

如有细微泄漏即会产生泡沫。

容量237毫升。

部件号 **9881419**

10621

Yellow-search leak detection oil sticks to surface and secures leak finding for extremely small leakages by producing bubbles.

Size 8 fl. oz (237 ml).

Part No 9881419



10621

10622

检漏试剂, 将检漏试剂加入制冷系统. 试剂将制冷呈红色, 且一泄漏会立即被发现. 试剂对制冷系统的运行无任何影响。

容量118毫升

每磅需要 $\frac{1}{8}$ 盎司。

部件号 **9881453**

10622

The trace-finder can be added to all refrigerants and refrigeration systems. Trace will make the refrigerant intense red and therefore leaks become immediately visible. The application does not affect the system in any way.

Size 4 fl. oz (118 ml), $\frac{1}{8}$ oz needed per/lb.

Part No 9881453



10622

温度计 - Thermometers

毛细管温度计 - Thermometers with capillary tube

普及型设计，可由背面或正面安装。
典雅的塑料结构，价格廉宜。

三种不同直径可供选购：
60, 80及100毫米。

Universal design which can be mounted from
the back or from the front. Elegant plastic
construction at very competitive price.
Available in three different diameters:
60, 80 or 100 mm.

温度计及安装法兰：范围：-40至+40摄氏度

Thermometer with mounting flange, Range: -40 up to +40 °C

名称 Designation	长度英寸 Length of capillary tube (m)	长度厘米 Ø mm	部件号 Part No
F-87-R-60-1.5	1.5	60	9881046
F-87-R-60-3.0	3.0	60	9881045
F-87-R-80-1.5	1.5	80	9881044
F-87-R-80-3.0	3.0	80	9881043
F-87-R-100-1.5	1.5	100	9881042
F-87-R-100-3.0	3.0	100	9881041
F-87-R-100-4.5	4.5	100	9881040
F-87-R-100-7.5	7.5	100	9881039

范围：-50至+50摄氏度

Range: -50 up to +50 °C

名称 Designation	长度英寸 Length of capillary tube (m)	长度厘米 Ø mm	部件号 Part No
F-87-R-100-3.0/50	3.0	100	4492715



F-87-R-60



F-87-R-100



CPF-83

CPF-83

直径52毫米温度计，内置于金属
片外壳中，安装内直径51毫米。
毛细管长度：1.5米。
范围：-40至+40摄氏度
部件号 9881035

CPF-83

Thermometer Ø 52 mm to be built-in metal sheet
housing (cabinets); inside diameter for mounting
Ø 51 mm. Length of capillary tube: 1.5 meter.
Range: -40 up to +40 °C.
Part No 9881035

15165

长方形远距离温度计, 可安装于箱柜内, 配备毛细管和感应头。测量远距离气体、液体等, 反应迅速。

技术数据:

温度范围: -40至+40摄氏度
 表盘直径: 15x30毫米
 安装尺寸: 26x58毫米
 毛细管长度: 1.5米
 可调节
 部件号 **9881038**



15165

15165

Rectangular distance-thermometer to be built into cabinets with capillary tube and sensing lead. Measures on distance gases, liquids, etc. with short reaction time.

Technical Data:

Temperature range: -40 °C up to +40 °C
 Scale dimension: 15x30 mm
 Built-in dimension: 26x58 mm
 Length of capillary tube: 1.5 m
 Adjustable.
 Part No **9881038**

15166

数字型温度计, 长方形

技术数据:

温度范围: -50至+150摄氏度
 安装尺寸: 26x45毫米
 毛细管长度: 3.0米
 部件号 **9884934**

15166

Digital distance thermometer, rectangular

Technical Data:

Temperature range: -50 °C up to +150 °C
 Built-in dimension: 26x45 mm
 Length of capillary tube: 3.0 m
 Part No **9884934**

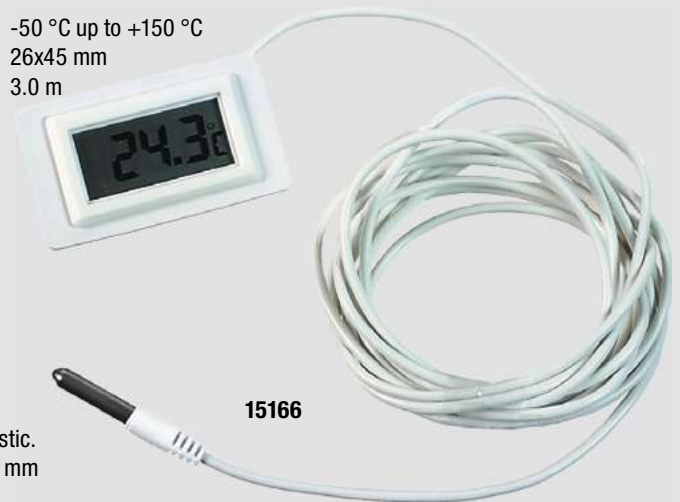

15166

温度计

15519/10

温度计配备挂钩, 挤压塑料制造
 温度计表盘: -40/+40摄氏度, 直径65毫米
 部件号 **4503643**

Thermometer

15519/10

Thermometer with hook made from extruded plastic.
 Scale: -40/+40 °C, ø65 mm
 Part No **4503643**

15140

数字棒式温度计
 温度范围: -50至+150摄氏度
 棒式感应器以不锈钢制造, 自己备护管和夹; 电池操作
 部件号 **9881048**

15140

Digital Stick-Thermometer
 Range: -50 up to +150 °C
 Stick sensor made from stainless steel with protection tube and clips; battery operated
 Part No **9881048**



15140



15519

温度计 - Thermometers

数字型袋装温度计 - Digital Pocket Thermometer

DT-150

温度范围: -40摄氏度至+150摄氏度
-40华氏度至+300华氏度
分辨能力: 0.1摄氏度或华氏度
精确度: +/-2华氏度或 +/-1摄氏度
温度计配备华氏/摄氏转换器、数据留存、
保护套及口袋夹。
部件号 **9884365**

DT-150

Range: -40 °C to 150 °C
-40 °F to 300 °F
Resolution: 0.1 °C or °F
Accuracy: +/- 2 °F or +/- 1 °C
The thermometer is equipped with F/C switch,
data hold, protective cover and pocket clip.
Part No **9884365**



红色线温度计探测器

DT-150

LP-88

红色线温度计探测器是手提轻巧式, 坚固耐用和实用的红外线温度计, 建立双重激光指针标记尺寸, 范围配合2个红色激光点。

技术数据:

温度范围: -60 °C至+550 °C
操作范围: +0 °C至+50 °C
分辨率: 0.1°C
准确度: ±2%读数/2 °C
电池寿命: 18小时
距离: 12:1
IP分类: 54
自动关机: 15秒后
发射率: 0.95-可调整的0.1至1
重量: 180克包括电池AAA*2件
部件号 **4686697**

Infrared Thermometer

LP-88

The LP-88 is a rugged and practical infrared thermometer with a pistol grip, which allows for contact free temperature measurement. Various temperatures can efficiently be measured within a room. The built-in laser pointer simplifies the measurement by marking the measurement area with two red laser points.

Technical Data:

Temperature range: -60 °C to +550 °C
Operating temperature: +0 °C to +50 °C
Resolution: 0.1 °C
Accuracy: ± 2% of display or 2 °C
Depending on which is greater
Battery life: 18 h
Distance spot: 12:1
IP classification: 54
Automatic shut-off: after 15 sec. of inactivity
Emissivity: 0.95 - adjustable
0.1 to 1 in .01-steps
Weight: 180 g incl. 2x AAA batteries
Part No **4686697**



LP-88

HALT-08

细小及便利的微型测试器主要用于湿度，风速，光的明亮和温度。

量度范围:

- 湿度: 10 至95%
- 风速: 0.4至30.0米/秒
- 光亮度: 0至20000 LUX
- 温度: -40摄氏度至+250摄氏度
-40华氏度至+482华氏度
- 电池: 9伏
- 部件号 **4661368**

HALT-08

Small and handy multi-test-instrument for humidity, air-speed, light intensity and temperature. A probe for temperature measuring is included.

Measuring ranges:

- Humidity: 10 to 95%
- Air-speed: 0.4 to 30.0 m/s
(km/h, MPH, knots, ft/min)
- Light intensity: 0 to 20000 LUX
- Temperature: -40 °C to +250 °C/
-40 °F to +482 °F
- Battery: 9 Volt
- Part No 4661368**



HALT-08



THB-85

THB-85

数字式的温度湿度计，准确地量度温度及湿度，设有数据停留及最低/最高按钮。

量度范围:

- 温度: -40摄氏度至+85摄氏度
-40华氏度至+185华氏度
- 湿度: 0至100%
- 准确度:
- 温度: +/-0.3摄氏度, +/-0.5华氏度
- 湿度: +/-2%
- 反应时: 10秒
- 电池: 9伏/大概维持160小时
- 部件号 **4661376**

THB-85

Digital thermo-hygrometer for precise measuring of temperature and humidity. With data-hold and min./max.-mode.

Measuring range:

- Temperature: -40 °C to + 85 °C/
-40 °F to + 185 °F
- Humidity: 0 to 100 %
- Accuracy:
- Temperature: +/- 0.3 °C +/- 0.5 °F
- Humidity: +/- 2 %
- Reaction time: 10 seconds
- Batteries: 9 Volt / lifetime approx.
160 hours.

Part No 4661376

温度控制器 - Thermostats

恒温器 - Thermostat

用于冷冻器的恒温器温度可在-35至+35摄氏度的范围内调整。

Thermostat for refrigeration adjustable in the range of -35 up to +35 °C

SP-ST
15安250伏+10安
部件号 9881005

SP-ST
15 A 250 V + 10 A
Part No 9881005



SP-ST



TSC-093

TSC-093
240伏
15A容量
10A介入容量
部件号 9884170

TSC-093
240 Vac
15 A capacitive
10 A inductive
Part No 9884170

TSC-094
用于室内温度控制的恒温器，
15A容量
10A介入容量
部件号 9884937

TSC-094
Thermostat for room temperature control,
15 A capacitive
10 A inductive
Part No 9884937



TSC-094



SL-128

声音量度器

SL-128

复合式声音量度器，配有数字式显示屏4种量度范围由30dB至130dB，包装于坚固的胶盒里，声音水平可以平行的通过两个过滤器(A+C)。量度的这个可以明确限定最高数值，防止量度过度。

量度范围： 由30至130 dB
 准确度： 0.1 dB
 频率： 31.5 赫至8 千赫
 过滤器评估： 风速仪

相应人类听觉
 种类C室线评估

周期对照： 快或慢
 精准度： +/- 1.5dB

部件号 **4661385**

Sound Level Meter

SL-128

This compact Sound Level Meter with digital display and 4 measuring ranges from 30 dB up to 130 dB, is delivered in a sturdy carrying case. The Sound Level can be balanced through two evaluation-filters (A+C). It is possible to define maximum value over a measuring period.

Measuring Range: from 30 up to 130 dB
 Resolution: 0.1 dB
 Frequency: 31.5 Hz up to 8 kHz
 Evaluation Filters: Type A - according to human hearing perception
 Type C- linear evaluation

Periodic Balance: fast or slow
 Accuracy: +/- 1.5 dB

Part No **4661385**



LA-40

风速仪

LA-40

复合式测风仪设有暂停功能，包装于坚固胶盒内

范围：
 0.4-30米/秒 或 1.4-108.0千米/小时
 80-5910英尺/分 或0.8-58.3 knots
 部件号 **4661393**

Air-Meter

LA-40

The compact Anemometer with hold-function supplied in a sturdy carrying case.

Range:
 0.4-30 m/second or 1.4-108.0 km/hour
 80-5910 feet/minute or 0.8-58.3 knots
 Part No **4661393**

数字型袋装温度计 - Condensate Pumps

SAHARA

SAHARA是因态电子冷凝水排放系统，特别设计成适合在狭小的空间使用，即使最小的墙壁式或分体式空翻亦同橡合用。

SAHARA的电子储层传感单元消除了有关定位一切后顾之忧。这种多用途的小装置是那么方便的，是你最佳的选择。

- 电子式电能控制系统(EECS)与警报电路
- 软启动与 "EECS"
- 无浮贴
- 热保护
- 微型水库 - 传感装置
- 超薄，便于安装的
- 令人惊讶的宁静
- 适用于所有壁挂式空揭
- CE和UL标记

技术参数:

电墨: 120/240伏特, 50/60 赫兹
自动感应

消耗功率: 最大16瓦, 空闲时0.25瓦

警报继: 5 A, 30 VDC, 250 VAC

电器: 故障时中断

容量: 最大12升/小时

放电头: >垂直20米

>水平100米

最大吸力1米

环境温度: 0 °C - 40 °C

材料: 阻燃ABS - UL 94 5 VA

放电管: 6 mm 内径

供应电 缆长度: 1.5米

泵传感 泵管: 总长度1.5M, 直径. 3.3毫米

泵尺寸: 135x46x32毫米

传感器 尺寸: 45x36 mm直径.

噪音值: 主主16分贝

部件号 **4678482**



SAHARA

SAHARA

SAHARA is a solid state electronic condensate removal system designed to fit neatly inside even the smallest high wall split air conditioners or trunking. The SAHARA's electronic reservoir sensing unit eliminates all worries about positioning. This versatile little unit is so easy-going that you're spoilt for choice.

- Electronic Energy Control System (EECS) with alarm circuit
- Soft start with "EECS"
- No float to stick
- Thermal protection
- Tiny reservoir - sensing unit
- Low profile for ease of mounting
- Amazingly quiet
- Fits all wall-mount splits
- CE and UL marked

Technical Data:

Power supply:	120/240 V, 50/60 Hz Auto sensing
Power consumption:	16 W max., 0.25 when idle
Alarm relay:	5 A, 30 VDC, 250 VAC Break on fault
Capacity:	12 litres/hour max.
Discharge head:	>20 m vertical, >100 m horizontal, 1 m max. Suction
Ambient temp:	0 °C - 40 °C
Material:	Flame retardant ABS-UL 94 5 VA
Discharge tube:	6 mm ID
Supply cable length:	1.5 meters
Pump-sensor-tube:	Lenght 1.5 m, dia. 3.3 mm
Dimensions pump:	135x46x32 mm
Dimensions sensors:	45x36 mm dia.
Noise Level:	~16 dB

Part No 4678482

KAROO

KAROO 是潜式冷凝排水泵，可以自动从冷藏柜，除湿机，风机盘管和空调系统等排去冷凝水。KAROO泵能安装在器材内的收集罐中。水位由一个敏感的电子能量控制系统(EECS) 进行测定，与此通过全面封装的电路控制泵的操作。

- 电子式电能控制系统(EECS)与警报电路
- 软启动与"EECS"
- 所有的电气元件经安全地封装，防止水分进入
- 可潜水
- 令人惊讶的宁静
- 功能强大，结构紧凑
- 内置过滤器和止回阀
- 无机械浮标贴
- CE和UL标记

技术参数:

电压: 120/240伏特, 50/60 赫兹
自动感应
消耗功率: 最大16瓦, 空闲时0.25瓦
警报继电器: 5 A, 30 VDC, 250 VAC
故障时中断
容量: 最大12升/小时
放电头: >垂直20米
>水平100米
最大吸力1米
环境温度: 0 °C - 40 °C
材料: 阻燃ABS - UL 94 5 VA
放电管: 6mm 内径
泵尺寸: 160x43x34毫米
噪音值: ~12分贝
部件号 4678512

KAROO

The KAROO drain pan pump is a submersible condensate removal pump designed to automatically remove condensate water from refrigerated cases, dehumidifiers, fan coils and airconditioning systems. The pump is intended to be installed within a collection tray inside the equipment. The water level is measured by an Electronic Energy Control System (EECS) this controls the operation of the pump via the fully encapsulated circuitry.

- Electronic Energy Control System (EECS) with alarm circuit
- Soft start with "EECS"
- All electrical components safely encapsulated against moisture ingress
- Submersible
- Amazingly quiet
- Powerful and compact
- Filter and non-return valves built in
- No mechanical floats to stick
- CE and UL marked

Technical Data:

Power supply: 120/240 V, 50/60 Hz Auto sensing
Power consumption: 16 W max., 0.25 when idle
Alarm relay: 5 A, 30 VDC, 250 VAC Break on fault
Capacity: 12 litres/hour max.
Discharge head: >20 m vertical, >100 m horizontal, 1 m max. Suction
Ambient temp: 0 °C - 40 °C
Material: Flame retardant ABS-UL 94 5 VA
Discharge tube: 6 mm ID
Dimensions pump: 160x43x34 mm
Noise Level: ~12 dB
Part No 4678512

KAROO



数字型袋装温度计 - Condensate Pumps

YUMA

冷凝泵易于安装，易于维护一是满安装者而设的冷凝泵。快速装配通用於YUMA冷凝泵。由智能电子能量控制系统 (EECS) 透遇将电路加强、控制功率等自动调节排去冷凝物所需要的能量，以保证安静起动和停止。

- 电子式电能控制系统(EECS)与警报电路
- 软启动与 "EECS"
- 功能强大，结构紧凑
- 无浮贴
- 热保护
- 令人惊讶的宁静
- 高水位警报和切出开关
- 垂直或水平安装
- 适用于所有壁挂式空拥
- CE和UL标记

技术参数:

电墨: 120/240伏特, 50/60 赫兹
自动感应
消耗功率: 最大16瓦, 空闲时0.25瓦
警报继 电器: 5 A, 30 VDC, 250 VAC
故障对中断
容量: 最大12升/小时
放电头: >垂直20米
>水平100米
最大吸力1 米
环境湿度: 0 °C - 40 °C
材料: 阻燃ABS - UL 94 5 VA
放电管: 6mm 内径
泵尺寸: 175x46x40 毫米
噪音值: ~18分贝
部件号 **4678520**



YUMA

YUMA

The YUMA condensate pump is easy to fit and easy to maintain - the pump is made for installers. Speedy fitting is assured with the YUMA. Completely automatic operation is enhanced by the intelligent Electronic Energy Control System (EECS) circuitry to guarantee quiet starting and stopping, as well as power control to regulate the amount of energy required to remove the condensate.

- Electronic Energy Control System (EECS) with alarm circuit
- Soft start with "EECS"
- Powerful and compact
- No float to stick
- Thermal protection
- Amazingly quiet
- High water alarm and cut-out switch
- Vertical or horizontal mounting
- Fits all high-wall-mount air conditioner
- CE and UL marked

Technical Data:

Power supply: 120/240 V,
50/60 Hz Auto sensing
Power consumption: 16 W max., 0.25 when idle
Alarm relay: 5 A, 30 VDC, 250 VAC
Break on fault
Capacity: 12 litres/hour max.
Discharge head: >20 m vertical,
>100 m horizontal,
1 m max. Suction
Ambient temp: 0 °C - 40 °C
Material: Flame retardant
ABS - UL94 5 VA
Discharge tube: 6 mm ID
Dimensions pump: 175x46x40 mm
Noise Level: ~18dB

Part No 4678520

GOBI

新GOBI泵是专为现代壁挂式空调而言量的冷凝水排放模组。新的设计和技术,使GOBI水感应系统不断创新。新GOBI泵采用了电子式电能控制系统 (EECS),微处理器控制,令到冷凝泵可以不起眼地流畅运行。新GOBI泵提供了一系列优势和好处:

- 电子式电能控制系统(EECS)与警报电路
- 软启动与 "EECS"
- 快速,简单的无困难安装
- 美学设计自然融合冷凝泵周围
- 热保护
- 令人惊讶的宁静
- 内置止回阀
- 适用于所有壁挂式空调
- CE和UL标记

技术参数:

电厦: 120/240伏特, 50/60 赫兹
自动感应
消耗功率: 最大16瓦, 空闲时0.25瓦
警报继电器: 5 A, 30 VDC, 250 VAC
故障时中断
容量: 最大12升/小时
放电头: >垂直20米
>水平100米
最大吸力1米
环境温度: 0 °C -40 °C
材料: 阻燃ABS - UL 945 VA
放电管: 6 mm 内径
泵尺寸: 286x61x53 毫米
噪音值: ~21 分贝
部件号 **4678538**

GOBI

The new GOBI is a condensate discharge module designed to be fitted below modern wall mounted air conditioners. The new design and technology makes the GOBI our most innovative water sensing system ever. The GOBI pump incorporates the electronic energy control system (EECS), microprocessor control delivers a smooth unobtrusive pump operation. The new GOBI offers a range of advantages and benefits for installers like:

- Electronic Energy Control System (EECS) with alarm circuit
- Soft start with "EECS"
- Quick, simple trouble free installation
- Aesthetic design blends in naturally into its surroundings
- Thermal protection
- Amazingly quiet
- Built-in non-return valves
- Fits all high-wall-mount air conditioners
- CE and UL marked

Technical Data:

Power supply: 120/240 V,
50/60 Hz Auto sensing
Power consumption: 16 W max., 0.25 when idle
Alarm relay: 5 A, 30 VDC, 250 VAC
Break on fault
Capacity: 12 litres/hour max.
Discharge head: >20 m vertical,
>100 m horizontal,
1 m max. Suction
Ambient temp: 0 °C - 40 °C
Material: Flame retardant
ABS - UL94 5 VA
Discharge tube: 6 mm ID
Dimensions pump: 286x61x53 mm
Noise Level: ~21dB
Part No 4678538



GOBI

应用工具 - Tools

夹取工具 - Pinch-Off-Tools

14285

夹取工具

夹取任何封闭冷冻系统内直径达 $\frac{3}{8}$ 英寸的吸管功效特强
部件号 9881530

14285

Pinch-Off-Tool in extra strong execution to pinch-off suction tubes on all hermetic refrigeration systems up to $\frac{3}{8}$ " diameter.
Part No 9881530

14280

用于生产的具有双重夹的夹钳可夹取直径 $\frac{3}{16}$ 英寸至 $\frac{3}{8}$ 英寸管
部件号 9881529

14280

Pinch-Off-Plier for production with double pinch for tubes of $\varnothing \frac{3}{16}$ " up to $\frac{3}{8}$ ".
Part No 9881529

RFA-105-FF

用于直径 $\frac{1}{4}$ 英寸, $\frac{3}{8}$ 英寸, $\frac{5}{16}$ 英寸和 $\frac{1}{2}$ 英寸的夹取工具
部件号 9881528

RFA-105-FF

Pinch Off Tool for $\varnothing \frac{1}{4}$ ", $\frac{5}{16}$ ", $\frac{3}{8}$ " and $\frac{1}{2}$ ".
Part No 9881528

14200

约达直径8毫米的夹钳
部件号 9881527

14200

Pinch-Off-Plier up to approx. $\varnothing 8$ mm
Part No 9881527



14285



14280

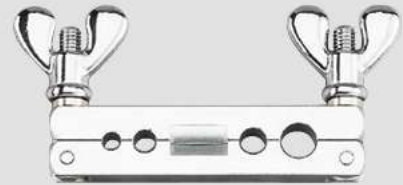

RFA-105-FF



14200

14215

毛细管切割器, 独一无二的切割工具, 可在不摇晃的情况下切割所有尺寸的毛细管。
部件号 9881087

14215

Capillary tube cutter a unique tool to cut all sizes of any capillary tubes without swadging the tube.
Part No 9881087



14215

14210

供(威科)顶级生产项目使用, 可立即钻透任何冰箱或冷库(家用)的充气管。仅需钻穿管便可进行系统排气或充气。在完成维修后使用夹钳在维修钻孔钳背后夹取然后焊接。

恢复维修钻孔钳由高质量钎钒钢制造, 配备可更换钻针和附加配件。
部件号 **9881526**

14210-01/10

备用针头直径6毫米, 10枚
部件号 **4665550**

14210

A REFCO top product item which enables an immediate piercing on the charging tube at any refrigerator or freezer (Domestic). Just pierce the tube and you are ready for evacuating or charging the system. After finishing the service job use pinch-off-plier and pinch behind the Service-Piercing Plier and braze the tube.

Recovery Service Piercing Plier made from high quality chrom vanadium steel with changeable piercing needle and access fitting.

Part No 9881526

14210-01/10

Spare Needle \varnothing 6 mm, 10 pcs.

Part No 4665550



14210

应用工具 - Tools

管切割器 - Tube Cutters

这是新款，持久力强的伸缩管切割器能够准确切割铜管。

- 四滚轴的追踪系统使管喉沿线走
- 可流畅地调较的调整把手
- 整合的进给系统防止轮和滚轴互相接触
- 强力耐用
- 商品质
- 包括备用切割轮

The new, durable telescopic tube cutter accurately cuts copper tubing.

- Four roller tracking system keeps tube from threading
- Smooth turning of adjustment knob
- Full-stop feed system prevents wheels and rollers from coming into contact
- Heavy duty
- High quality
- Includes spare cutting wheel



RS-67

名称 Designation	描述 Description	部件号 Part No
RS-16	管切割器 Tube cutter 1/8" to 5/8"	4682722
RS-25	管切割器 Tube cutter 1/8" to 1"	4682730
RS-35	管切割器 Tube cutter 1/8" to 1 3/8"	4682748
RS-42	管切割器 Tube cutter 1/8" to 1 5/8"	4682756
RS-67	管切割器 Tube cutter 1/4" to 2 5/8"	4686904



RS-16



RS-25



RS-35



RS-42



RS-001/3

RS-001/3

备用切割轮可供 RS-16, RS-25, RS-35, RS-42, RS-67, 3 pcs.
部件号 4687097

RS-001/3

Spare cutting wheel for RS-16, RS-25, RS-35, RS-42, RS-67, 3 pcs.
Part No 4687097



RFA-209-01/3

RFA-209-01/3

备用刀片可供 RS-16, RS-25, RS-35, RS-42 和 RFA-209-STYLO/-HD 由坚韧耐用的钴铸造
部件号 4687065

RFA-209-01/3

Spare blades for RS-16, RS-25, RS-35, RS-42 and RFA-209-STYLO/-HD, made of tough long life cobalt, 3 pcs.
Part No 4687065

14310

直径1/8英寸至7/8英寸大号微型管切割器，配备便于切割的滚轴。
部件号 **9881633**

14301/3

供14300和14310使用的切割轮。
部件号 **4687077**

RFA-174-F

大号-微型-管
范围：直径3/8至1 1/8英寸
部件号 **9881632**

RFA-312-FB

强力切割器直径1/4至1 1/8英寸
包括备用切割轮。
部件号 **9881629**

RFA-001/3

切割轮由最佳HSS高质钢制造，
强化可用于RFA-174-F, RFA-206-FB,
RFA-274-FC, RFA-312-FB。
部件号 **4687096**

14338

[威科]滚轴是管道建设的理想工具。
便于铜焊或熔化式连接。
滚轴可代替切割轮使用。
部件号 **9881622**

14310

Big mini-tube cutter with rollers for easy cutting \varnothing 1/8" to 7/8".
Part No 9881633

14301/3

Cutting wheel for 14300 and 14310, 3 pcs.
Part No 4687077

RFA-174-F

Big-Mini-Cutter
Range: \varnothing 3/8" - 1 1/8"
Part No 9881632

RFA-312-FB

Heavy-Duty Cutter \varnothing 1/4" - 1 1/8"
including spare cutting wheel.
Part No 9881629

RFA-001/3

Cutting Wheel from finest HSS high quality steel, hardened for RFA-174-F, RFA-206-FB, RFA-274-FC, RFA-312-FB, 3 pcs.
Part No 4687096

14338

REFCO-roller is an ideal tool for tubing construction. Handy for making braze- or sweat-type connections. Roller is used in place of cutting wheel.
Part No 9881622



14310

RFA-174-F



RFA-312-FB



14338



RTC-29

管切割器的备用切割轮

这款坚固的管切割器的手柄是用强化的玻璃纤维塑料造成的。它的棘轮管机是为了在狭窄的空间工作而特别设计的，切割轮是有预应力的后备轮妥善的放在手柄内。

RTC-13-001

更换切割轮
部件号 **4681416**

RTC-29

8-29 mm
部件号 **4678814**

RTC-29-001

更换切割轮
部件号 **4681424**

Ratchet Tube Cutters

Sturdy tube cutter with fibreglass-reinforced plastic handle. The ratchet is especially designed for jobs in narrow spaces. The cutting wheel can be prestressed. The spare wheel is well placed in the handle.

RTC-13-001

replacement cutting wheel
Part No 4681416

RTC-29

8-29 mm
Part No 4678814

RTC-29-001

replacement cutting wheel
Part No 4681424

应用工具 - Tools

开张工具 - Flaring Tools

扩喇叭口（偏心旋转式）工具

RF-888-Z

45度偏心旋转式扩喇叭口英制尺寸用最坚实钢材制造，适用 $\frac{3}{16}$ 、 $\frac{1}{4}$ 、 $\frac{5}{16}$ 、 $\frac{3}{8}$ 、 $\frac{1}{2}$ 、 $\frac{5}{8}$ 、 $\frac{3}{4}$ 英寸套装塑料盒设计
部件号 4506171

RF-888-M

45度偏心旋转式扩喇叭口英制尺寸坚实钢材制造，适用较坚实喉管外径6, 8, 10, 12, 14, 16, 19mm
套装塑料盒设计
部件号 4506180

525-F

"Grabber" 开张工具45度可供任何公制或英寸尺寸的管使用，分别为5至16毫米和 $\frac{3}{16}$ 至 $\frac{5}{8}$ 英寸外径
部件号 9881571

RF-899-Z

棘轮轮形扩喇叭口
英制尺寸，容易使用在一些较狭窄的地方用最坚硬材料，适用较坚实喉管 $\frac{3}{16}$ 、 $\frac{1}{4}$ 、 $\frac{5}{16}$ 、 $\frac{3}{8}$ 、 $\frac{1}{2}$ 、 $\frac{5}{8}$ 、 $\frac{3}{4}$ 套装
塑胶盒设计
部件号 4666068

STK-3

新的工具包包括RS-35切管器直径3-35mm ($\frac{1}{8}$ " - $1\frac{3}{8}$ "），RFA-209的内外部铰刀和RF-888-Z 45°偏心扩管器与英制尺寸自动转矩发布对管中的外径为：直径 $\frac{3}{16}$ "、 $\frac{1}{4}$ "、 $\frac{5}{16}$ "、 $\frac{3}{8}$ "、 $\frac{1}{2}$ "、 $\frac{5}{8}$ "、 $\frac{3}{4}$ " 包装在一个坚固的塑料盒
部件号 4687018

Eccentric Flaring Tool

RF-888-Z

45° Eccentric Flaring Tool in inch sizes. Made of forged high quality steel for tubes with an outside diameter of: \emptyset $\frac{3}{16}$ "、 $\frac{1}{4}$ "、 $\frac{5}{16}$ "、 $\frac{3}{8}$ "、 $\frac{1}{2}$ "、 $\frac{5}{8}$ "、 $\frac{3}{4}$ ". The unit is supplied in a sturdy plastic case.
Part No 4506171

RF-888-M

45° Eccentric Flaring tool in metric sizes. Made of forged high quality steel for tubes with an outside diameter of: \emptyset 6, 8, 10, 12, 14, 16, 19 mm. The unit is supplied in a sturdy plastic.
Part No 4506180

525-F

"Grabber" flaring tool 45° applicable for all tubes in metric and inch sizes from 5 to 16 mm respectively $\frac{3}{16}$ " to $\frac{5}{8}$ " O.D.
Part No 9881571

RF-899-Z

Ratchet Type Flaring Tool in inch sizes for easy operation if space is tight. Made of forged high quality steel for tubes with outside diameter of: $\frac{3}{16}$ "、 $\frac{1}{4}$ "、 $\frac{5}{16}$ "、 $\frac{3}{8}$ "、 $\frac{1}{2}$ "、 $\frac{5}{8}$ "、 $\frac{3}{4}$ ". The unit is supplied in a sturdy plastic case.
Part No 4666068

STK-3

New toolkit consisting of RS-35 tube cutter \emptyset 3-35mm ($\frac{1}{8}$ " - $1\frac{3}{8}$ "），RFA-209 inner outer reamer and RF-888-Z 45° eccentric flaring tool with automatic torque release in inch sizes for tubes with an outside diameter of: \emptyset $\frac{3}{16}$ "、 $\frac{1}{4}$ "、 $\frac{5}{16}$ "、 $\frac{3}{8}$ "、 $\frac{1}{2}$ "、 $\frac{5}{8}$ "、 $\frac{3}{4}$ ". Supplied in a sturdy plastic case.
Part No 4687018



RF-888-Z



RF-899-Z



525-F



STK-3



RF-175-FS

45度式扩喇叭口及扩管箍工具
用于高质量金属钢锻制造
适用于外径喉管:
1/8, 3/16, 1/4, 5/16, 3/8, 1/2, 5/8英寸
套装塑料盒设计
部件号 **4506198**



RF-175-FS

45° Flaring and Swaging Tool in inch sizes. Made of forged high quality steel for tubes with an outside diameter of: \emptyset 1/8", 3/16", 1/4", 5/16", 3/8", 1/2", 5/8". The unit is supplied in a sturdy plastic case. Part No **4506198**



RF-175-FS

骤然和型锻工具(公制与英寸)

Flaring - Swaging Tubing Tools metric and inch

RF-275-FS/RF-275-FSM



RF-500-FB

RF-275-FS

公制尺寸的45度骤然和型锻工具。高质量锻钢制造，用于外部直径为 3/16", 1/4", 5/16", 3/8", 1/2", 5/8", 英寸的圆管 以上这些尺寸均可进行骤然和型锻。供货以坚固的塑料箱包装 部件号 **9881575**

RF-275-FS

45° Flaring and Swaging Tool in inch-sizes. Made of forged high quality steel for tubes with an outside-diameter of: 3/16", 1/4", 5/16", 3/8", 1/2", 5/8" These diameters can be flared as well as swaged. The unit is supplied in a special sturdy plastic case. Part No **9881575**

RF-275-FSM

公制尺寸的45度骤然和型锻工具。高质量锻钢制造，用于外部直径为 6, 8, 10, 12, 15, 16毫米的圆管 以上这些尺寸均可进行骤然和型锻。供货以坚固的塑料箱包装 部件号 **9881574**

RF-275-FSM

45° Flaring and Swaging Tool in metric-sizes. Made of forged high quality steel for tubes with an outside-diameter of: 6, 8, 10, 12, 15, 16 mm These diameters can be flared as well as swaged. The unit is supplied in a special sturdy plastic case. Part No **9881574**

RF-500-FB

所有公制尺寸的45度开张和型锻工具。高质量锻钢制造，用于外部直径为 3/16, 1/4, 5/16, 3/8, 1/2, 5/8, 3/4 英寸的圆管 供货以坚固的塑料箱包装 部件号 **9881577**

RF-500-FB

45° Flaring Tool in inch-sizes. Made of forged high quality steel for tubes with an outside-diameter of: 3/16", 1/4", 5/16", 3/8", 1/2", 5/8", 3/4" The unit is supplied in a sturdy plastic case. Part No **9881577**



TELL-7

TELL-7

横弓式弯管器可适用于以下外径 外径 1/4, 5/16, 3/8, 1/2, 5/8, 3/4, 7/8英寸 套装塑胶盒设计 部件号 **4666076**

TELL-7

Cross-bow-type Tube Bender Set for the following outside diameter: 1/4", 5/16", 3/8", 1/2", 5/8", 3/4", 7/8" Supplied in a sturdy plastic case. Part No **4666076**

应用工具 - Tools

弯管弹簧 - Tube Bending Springs

弯管弹簧

Tube Bending Springs

名称 Designation	管外径/英寸 O.D. tube (inch)	毫米 tube-Ø (mm)	部件号 Part No
BS-4	1/4"	6	9881648
BS-5	5/16"	8	9881642
BS-6	3/8"	10	9881641
BS-7	7/16"		9881640
BS-8	1/2"	12	9881639
BS-10	5/8"	16	9881638
BS-12	3/4"		9881637

BS-77

7种尺寸套件塑料袋包装
部件号 9881635

BS-77

Set of all 7 sizes packed in blister
Part No 9881635

BS-77M

公制尺寸套件(BS-4, BS-5, BS-6, BS-8, BS-10)
塑料袋包装
部件号 9881636

BS-77M

Set of metric sizes (BS-4, BS-5, BS-6,
BS-8, BS-10) packed in blister
Part No 9881636

BS-44

4种尺寸套件(BS-4, BS-6, BS-8, BS-10)
塑料袋包装
部件号 9884890

BS-44

Set of 4 sizes (BS-4, BS-6, BS-8, BS-10)
packed in blister
Part No 9884890

弯管器

Tube Benders

名称 Designation	直径 Ø	部件号 Part No
RFA-364-FH-04	1/4"	9881670
RFA-364-FH-05	5/16"	9881669
RFA-364-FH-06	3/8"	9881668
RFA-364-FH-08	1/2"	9881667
RFA-364-FH-10	5/8"	9881666
RFA-364-FH-12	3/4"	9881665

RFA-368-FH

手动式弯管器
用于管外径1/4", 5/16"及3/8"英寸能弯90度

部件号 9881657

RFA-368-FH

Triple Header Tube Bender
Bends all tubes with an O.D. tubing diameter of
1/4", 5/16" and 3/8" to 90° bend
Part No 9881657



RFA-368-FH

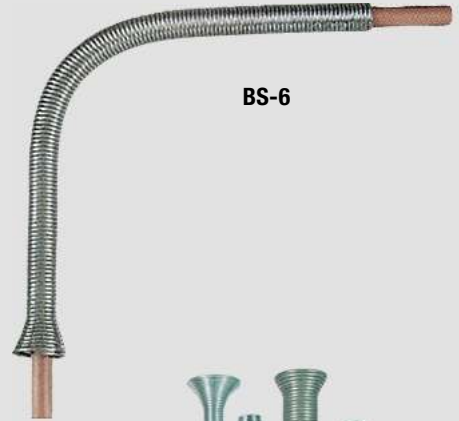

BS-6



BS-77



RFA-364-FH-04

RFA-209-STYLO

便利打磨棒 (deburrer)。刃头可转动。
部件号 **9883750**

RFA-209-STYLO

Handy deburrer. Blade can be swivelled.
Part No 9883750

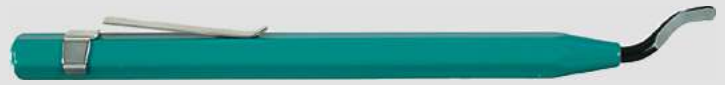

RFA-209-STYLO-HD

重型去毛刺工具，旋转刀片
- 清除钢，铝，铜和塑料粗糙或不规则的边缘
- 可更换刀片，坚韧耐用的钴铸造
部件号 **4687051**

RFA-209-STYLO-HD

Heavy duty deburring tool with rotating blade
- Removes rough or irregular edges of steel, aluminium, copper and plastic
- replaceable blades made of tough long life cobalt
Part No 4687051

RFA-209-STYLO



RFA-209-01/3

备用刀片供 RFA-209-STYLO-HD 和 RS管切割器系列，由坚韧耐用的钴铸造
部件号 **4687065**

RFA-209-01/3

Spare blades for RFA-209-STYLO/-HD and RS tube cutter series, made of tough long life cobalt, 3 pcs.
Part No 4687065

RFA-209-STYLO-HD



RFA-209-01/3

应用工具 - Tools

扩展器工具 - Expander Tools

HY-EX-6

新型液压扩管器工具包有6个扩展头，以覆盖所有的大小英制尺寸直径 $\frac{3}{8}$ "、 $\frac{1}{2}$ "、 $\frac{5}{8}$ "、 $\frac{3}{4}$ "、 $\frac{7}{8}$ "、 $1\frac{1}{8}$ "。该套装包括一个坚固的去毛刺工具，是装在一个方便的塑料盒。这款轻便的扩管器采用液压动力，只用了一个小泵就能使铜、铝管造出完美扩管功能

此工具为您提供以下功能：

方便单手操作：

液压机构和释放按钮使单手模锻

简易地选择正确的激光雕刻

只需要上紧扩管头在扩管器上就能做出扩管

佔用空间少

紧凑，手枪外形使得它能够适应最小手和容易达到效果

120°角度：

手腕不需要太大力来推动液压泵

可互换头：

适合所有常见的HVA /R英制尺寸的铜管。扩管头在公制尺寸的铜管都可用，还兼容威科扩管系统：

完美的配件可提升现有的手动扩管器。

包括去毛刺工具RFA-209-STYLO-HD：

可轻松安装的扩展头。

尺寸：

长度：25厘米(10")，宽度：4.5厘米(1.75")

高度：12厘米(5")

重量：1.2千克(2.6磅)

管材料：软管只：铜，铝，黄铜

部件号 **4687047**

HY-EX-6

New Hydraulic Expander tool kit with 6 expander heads to cover all imperial size tubes of $\frac{3}{8}$ "、 $\frac{1}{2}$ "、 $\frac{5}{8}$ "、 $\frac{3}{4}$ "、 $\frac{7}{8}$ "、 $1\frac{1}{8}$ " diameter.

This set includes a sturdy deburring tool and is delivered in a handy plastic case.

Using hydraulic power this lightweight expander makes a perfect expansion of copper and aluminium tubing with only a few pumps.

This tool offers you the following features:

Easy single hand operation:

Hydraulic mechanism and release button make onehanded swages possible.

Simply select the correct laser-engraved expander head, thread it on the tool and make a quality swage.

Small space capable:

A compact, pistol shape allows it to fit into the smallest and easy to reach spots.

120° angle:

Requires less power to pump, provides a natural wrist angle.

Interchangeable heads:

Fits all common HVAC/R imperial size copper tubing. Heads for all metric size copper tubing are available as well.

Compatible with REFCO expander systems:

Perfect accessory to upgrade existing manual expander kits.

Includes deburring tool RFA-209-STYLO-HD:

Allows easy installation for expander heads.

Dimensions:

Length: 25 cm (10"), Width: 4.5 cm (1.75"), height: 12 cm (5")

Weight:

1.2 kg (2.6 lbs)

Tube materials:

Soft tubing only: copper, aluminium, brass

Part No 4687047



HY-EX-6

14297扩展器, 工具·组成套
包括扩展器夹和7个夹头, 包装于适用方便的工具盒中, 可供所有 $\frac{3}{8}$ ", $\frac{1}{2}$ ", $\frac{5}{8}$ ", $\frac{3}{4}$ ", $\frac{7}{8}$ ", 1", 1 $\frac{1}{8}$ " 英寸等直径的管使用。
部件号 **9881688**

14297 Expander-tool-set
complete with expander-plier and 7 heads in practically and handy steel box to cover all inch size tubes of $\frac{3}{8}$ ", $\frac{1}{2}$ ", $\frac{5}{8}$ ", $\frac{3}{4}$ ", $\frac{7}{8}$ ", 1", 1 $\frac{1}{8}$ " diameter.
Part No **9881688**

名称 Designation	直径 Ø	部件号 Part No
14297-3/8"	$\frac{3}{8}$ "	9881686
14297-1/2"	$\frac{1}{2}$ "	9881685
14297-5/8"	$\frac{5}{8}$ "	9881684
14297-3/4"	$\frac{3}{4}$ "	9881683
14297-7/8"	$\frac{7}{8}$ "	9881682
14297-1"	1"	9881681
14297-1 1/8"	1 $\frac{1}{8}$ "	9881680
14297-1 3/8"-35mm	1 $\frac{3}{8}$ "	4496362
14297-1 5/8"	1 $\frac{5}{8}$ "	4496371



14297



14297-3/8"

链型扳手

TW-8
完整的转力矩扳手工具存放於便利盒内
扭矩: 10-75 Nm
扳手尺寸: 17, 19, 22, 24, 26, 27, 29毫米
部件号 **4666034**

BR-4IN1
本型号的刷子可以在不用借助任何其他工具的情况下清洁 $\frac{1}{2}$ "和 $\frac{3}{4}$ "管子的内壁和外壁, 并可以快速将污垢以及机油和锈渍与金属脱离。
部件号 **4677621**

Torque wrenches

TW-8
The complete Torque wrenches kit in a handy case. Torque: 10-75 Nm
Size of wrenches: 17, 19, 22, 24, 26, 27, 29 mm
Part No **4666034**

BR-4IN1
This brush cleans $\frac{1}{2}$ " or $\frac{3}{4}$ " tubes on the inside as well as on the outside without changing the tool. Release fast and easy copper parts from dirt and residues like fat and corrosion.
Part No **4677621**



TW-8



BR-4IN1

应用工具 - Tools

手提工具 - Hand Tools

R6950
棘轮扳手
部件号 **9881547**

RMK
冷冻机承窝 (插座) 套
全套如图, 供20件, 公制尺寸
部件号 **4678792**

R6725ZK
同上, 但以英寸为尺寸
部件号 **9881532**

RFA-127-C
棘轮扳手
平方: $\frac{1}{4}$ x $\frac{3}{8}$ 英寸, 及 $\frac{3}{16}$ x $\frac{5}{16}$ 英寸
部件号 **9881466**

RFA-127-OFFSET
特别角度双向操作专用扳手
尺码: $\frac{1}{4}$ x $\frac{3}{8}$ 英寸, 及 $\frac{3}{16}$ x $\frac{5}{16}$ 英寸
部件号 **4506201**

充气油泵

21702
REFCO充气油泵消除了在进行压缩机充泊时将空气和湿气吸入冷冻系统的危险。在充泊时不需抽取压缩机, 这样便将充泊时间减少了70%。充泊一夸特仅需将此活塞抽压20次。
部件号 **9881559**

21751
换泊泵
部件号 **9881557**

翅梳

14142
适用于各种尺寸的翅梳, 附可更换的备用梳, 塑料袋包装。
部件号 **9881562**

镜子

14225
环状口袋镜, 伸缩直径1 1/2英寸, 长度=127-500毫米
部件号 **9881560**

电磁阀磁性控制器

SVOM-18
此产品专为维修工程师而设的维修工具
最快捷及方便手动操作电磁阀
能于几秒时间内手动改变控制电磁阀电流
此设计已证实适合大部分电磁阀
部件号 **4660507**

R6950
Ratchet wrench
Part No **9881547**

RMK
Refrigeration socket set. Complete set as per picture, 20 pcs., metric sizes
Part No **4678792**

R6725ZK
same as above, but inch sizes
Part No **9881532**

RFA-127-C
Ratchet wrench
Square: $\frac{1}{4}$ " x $\frac{3}{8}$ " and $\frac{3}{16}$ " x $\frac{5}{16}$ "
Part No **9881466**

RFA-127-OFFSET
Ratchet Wrench offset
Square: $\frac{1}{4}$ " x $\frac{3}{8}$ " and $\frac{3}{16}$ " x $\frac{5}{16}$ "
Part No **4506201**

Charge Oil Pumps

21702
The REFCO charge-oil pump eliminates the danger of drawing air and moisture into a refrigeration system when charging a compressor with oil. It charges without pumping the compressor down thus reducing charging time by over 70%. It pumps one quart in 20 full strokes of the piston.
Part No **9881559**

21751
Change-oil pump
Part No **9881557**

Fin Comb

14142
Fin comb to fit all sizes, with additional replace spare comb, in plastic bag.
Part No **9881562**

Mirror

14225
Circular Pocket Mirror, telescopic \varnothing 1 1/2", L = 127-500 mm
Part No **9881560**

Solenoid Valve Operating Magnet

SVOM-18
The ideal addition to the professional service engineer's toolkit.
- the quickest and easiest way to operate solenoid valves manually
- converts electrically operated solenoid valves in hand operated valves in seconds
- Proven design which fits most of solenoid valves
Part No **4660507**



R6950



RMK



RFA-127-C



RFA-127-OFFSET



21702



21751



14142



14225



SVOM-18

13250

便携式氧气工具，立即提供火力和温度的稳定性。氧气梅是可以再充气的，客户只需交充气费用。也可以使用充气转换器（13251）由大的氧气梅转到细的氧气梅。一次性的气搏也可以向瑞士威科或你的本地供应商购买。

烧焊工具包括：

- 架
- 2.5公升氧气槽(内有500公升氧气)
- 氧气专用的压力调节棒
- 压力调节器防止气体倒流
- 2米长的喉有防止倒流工能
- 燃烧柄
- 1分烧焊也
- 安全眼镜
- 点火器

尺寸： 46x28x15 厘米
重量： 7.8公斤
火力： 2830度
部件号 **9881719**



13250

The portable gas-oxygen kit gives you the possibility to obtain a constant immediate regulation of the flame and the temperature. The customer-owned oxygen cylinder (EU-standard) can be exchanged by your dealer for a refilled bottle. Only pay the filling.

You also have the possibility of filling small oxygen cylinder from a large standard cylinder by using the oxygen charging adapter f/f (13251). The one-way gas cartridge can be bought from REFCO or at your local gas supplier. Hold a number of gas cartridges in stock.

The soldering kit consists of:

- Rack
- Oxygen cylinder 2.5 l (content 500 l oxygen)
- Pressure regulator for oxygen
- Pressure regulator for gas with nonreturn valve
- Hose set 2 m with flash-back arrester
- Burner handle
- Burner nozzle size 1
- Safety goggles
- Lighter

Dimensions: 46x28x15 cm
Weight: 7.8 kg
Flame temperature: 2830 °C

Part No 9881719



13252

13847

单次性气梅(600毫升)
部件号 **4661287**

13847

One-way gas cartridge (600 ml) for soldering unit 13250

Part No 4661287



13253

13252

双向燃烧器
部件号 **9881716**

13252

Two-way burner
Part No 9881716



13254

13253

单向氧气燃烧器

13253

One-way burner for gas-oxygen
Size 1 (Standard) **Part No 9883818**
Size 3 **Part No 9881715**

1号(标准) 部件号 **9883818**
3号 部件号 **9881715**

13254

无氧气燃烧器把手
部件号 **9881714**

13254

Handle complete without burner for gasoxygen
Part No 9881714



13847

16847

16867

丙镜气炬烧

Propane Torch

16847

丙烷气罐
淨重: 400克(14.1盎司)
部件号 **9881693**

16847

Propane one-way cartridge
Net weight: 400 g (14.1 oz)
Part No 9881693

16867

丙统气罐
淨重: 400克(14.1盎司)
部件号 **4661261**

16867

MAP gas cylinder
Net weight: 400 g (14.1 oz)
Part No 4661261



16868

16868

重型的丙烷调气节炬以火适应压力已持续性操作。
部件号 **4684066**

16868

Heavy duty spark igniting head propane torch, pressure regulated for consistent operation.
Part No 4684066



16860

16860

伽盘绕火焰·焊气炬, 用于丙统和混合气上, 压力已经调节。
部件号 **4685950**

16860

Swirl flame brazing torch, to be used with propane and MAP gas cylinder, pressure regulated.
Part No 4685950

应用工具 - Tools

球形维修阀 - Ball Service Valve



CX-AUTO-1/4 SAE

使用本新型维修阀进行以充气的A/C系统清除障碍的维修工作。REFCO提供所有这些自动维修阀的普通螺纹阀。

Trouble free service work when using this new service valve for A/C systems charged with R134a. REFCO offers all common threads on these Auto-Service-Valves.

CX-AUTO-B-1/4 英寸SAE
自动阀1/4英寸SAE连接, 蓝色
部件号 **9881193**

CX-AUTO-B-1/4" SAE
Auto-valve 1/4" SAE connection, blue
Part No 9881193

CX-AUTO-R-1/4 英寸SAE
同上, 红色
部件号 **9881191**

CX-AUTO-R-1/4" SAE
Idem, red
Part No 9881191

CX-AUTO-B-3/8 英寸SAE
自动阀3/8英寸SAE连接, 蓝色
部件号 **9881190**

CX-AUTO-B-3/8" SAE
Auto-valve 3/8" SAE connection, blue
Part No 9881190

CX-AUTO-R-3/8英寸SAE
同上, 红色
部件号 **9881189**

CX-AUTO-R-3/8" SAE
Idem, red.
Part No 9881189

CX-AUTO-B-M14x1.5毫米
自动阴(内) 阔 M 14x1.5毫米, 蓝色
部件号 **9881188**

CX-AUTO-B-M 14x1.5 mm
Auto-valve female, M14 x 1.5 mm, blue
Part No 9881188

CX-AUTO-R-M 14x1.5毫米
同上, 红色
部件号 **9881187**

CX-AUTO-R-M 14x1.5 mm
Idem, red
Part No 9881187

V-R-B-001/10
形环, 适用于低边阀 蓝色, 10枚
部件号 **9884847**

V-R-B-001/10
HNBR O-Ring suitable for low side valve blue, RC01-B and RC02-B, 10 pcs.
Part No 9884847



V-R-B-001

V-R-R-002/10
HNBR O-形环, 适用于高边阀 红色, 10枚
部件号 **9884848**

V-R-R-002/10
HNBR O-Ring suitable for high side valve, red, RC01-R and RC02-R, 10 pcs.
Part No 9884848



V-R-R-002

RC01-B

密集型场地维修耦合瓣, 用于 R134a.
提供安全可靠的排气 和充气。
连接为1/4"英寸SAE, 6枚球, 镀铬,
蓝色。
部件号 **9884949**

RC01-B

Compact field service coupling for R134a.
Provides a safe and reliable evacuating and
charging. Connection 1/4" SAE, 6 balls, chrome
plated, blue.
Part No 9884949



RC01-B

RC01-R

同上, 红色。
部件号 **9884948**

RC01-R

Idem, red
Part No 9884948

RC02-B

维修球阀压低冲注接头I连开关阀(蓝色)
部件号 **4494599**

RC02-B

Idem, blue, connection M14x1.5
Part No 4494599



RC01-R

RC02-R

高压冲注接头/连开关阀(红色)
部件号 **4494602**

RC02-R

Idem, red
Part No 4494602

RV-10/10

黄铜快速接驳法咀(高压) 带有保护盖连铜
密封垫和阀芯1/4" SAE,高压,共10个。
部件号 **9884822**

RV-10/10

Brass-Quick-Valve L.P. with protection cap
complete with valve core mounted and copper
seal gasket 1/4" SAE, low side, 10 pcs.
Part No 9884822



RC02-B

RV-20/10

黄铜快速接驳法咀(高压) 带有保护盖连铜
密封垫和阀芯1/4" SAE,高压,共10个。
部件号 **9884823**

RV-20/10

Brass-Quick-Valve H.P. with protection cap
complete with valve core mounted and copper
seal gasket 1/4" SAE, high side, 10 pcs.
Part No 9884823

RC-1234yf-B

低压快速接驳阀
部件号 **4687054**

RC-1234yf-B

Low pressure service valve
Part No 4687054

RC-1234yf-R

高压快速接驳阀
部件号 **4687053**

RC-1234yf-R

High pressure service valve
Part No 4687053

RV-1234yf-LP/10

黄铜快速接驳法咀(低压) 带有保护盖连铜
密封垫和阀芯1/4" SAE,低压,共10个。
部件号 **4687059**

RV-1234yf-LP/10

Brass Quick-Valve L.P. with protection cap
complete with valve core mounted and copper
seal gasket 1/4" SAE, low side, 10 pcs.
Part No 4687059



RV-LP



RV-HP

RV-1234yf-HP/10

黄铜快速接驳法咀(高压) 带有保护盖连铜
密封垫和阀芯1/4" SAE,高压,共10个。
部件号 **4687060**

RV-1234yf-HP/10

Brass Quick-Valve H.P. with protection cap
complete with valve core mounted and copper
seal gasket 1/4" SAE, high side, 10 pcs.
Part No 4687060



RC-1234yf-B



RC-1234yf-R

应用工具 - Tools

附件 - Accessories

13400

此种酸检验包共含5瓶, 可进行5次制冷剂油酸检验, 以确认酸是否正常。

将12滴油注入其中1瓶, 液体的颜色将改变:

- 黄色 = 酸不好
- 绿色 = 还可以
- 蓝色 = 良好, 油正常

适用于矿物和合成油

部件号 **9881446**

13400

This Acid-Test-Kit includes 5 bottles to make 5 checkups of refrigerant-oil to find out if acid or o.k.

Put 12 drops of oil into one bottle; color of the liquid will change to

- yellow = Acid, Oil not o.k.
- green = still o.k.
- blue = very good Oil o.k.

Can be used for mineral and synthetic oils.

Part No **9881446**



13400

用于1/4英寸SAE的附加阀工具

Access Valve-Tools for 1/4" SAE

32520

阀心更换工具

部件号 **9880893**

32520

Valve core replacing tool

Part No **9880893**

32520-555

成套垫圈O形环组

部件号 **9880892**

32520-555

Gasket O-ring set complete

Part No **9880892**



32520

A-31999-R/10

红色阀心, 聚四氟乙烯和氯丁二烯橡胶垫圈用于各种温度下的HCFC (R12, R22, R502), 以及HCF=R134a 达120摄氏度。袋装10枚。

部件号 **9883488**

A-31999-R/10

Valve core red with Teflon and Neopren gasket for HCFC (R12, R22, R502) for all temperatures and for HCF = R134a up to 120° celsius. Bag containing 10 pcs.

Part No **9883488**

A-31999-R/100

红色阀心, 100枚

部件号 **9883854**

A-31999-R/100

Valve core red, 100 pcs.

Part No **9883854**



A-31999-R

A-32000

阀心工具螺丝刀, 包括6个附加阀心和1个附加阀心移换器及塞子。

部件号 **9880890**

A-32000

Valve core tool screwdriver contains 6 extra cores and one extra core remover and tap.

Part No **9880890**

A-32000-01/10

阀心移换器, 10枚

部件号 **9884849**

A-32000-01/10

Core remover, 10 pcs.

Part No **9884849**

A-32000-02/10

螺纹切割器, 10枚

部件号 **9884850**

A-32000-02/10

Thread cutter, 10 pcs.

Part No **9884850**



A-32000



A-32000-01



A-32000-02

功能

- 安装便利...可使用快速“掀入式托架”安装于压缩机的栏板上...或使用螺丝刀通过安装孔安装于任何方便之处。
- 使用或不使用启动电容器均可

ICG-220

普及型继电器, 适用于任何品牌能量从 1/2 至 1/2 马力的各类密封式压缩机。这是节省库存费用的选择, 因无其他继电器可替代。220伏-50周
部件号 **9881406**

SPP-220

普及型电力继电器, 适用于能量从 1/2 至 100 马力的各类窗式空调机组。这是节省库存费用的选择, 因无其他继电器可替代。110-240 伏
部件号 **9881402**

Features

- Easy to install .. Can be mounted on the fence of the compressor with quick "snap-on-bracket" ... or installed in any convenient location by using screws through the mounting holes.
- Can be used with or without a start capacitor.

ICG-220

Universal relay can be used on all hermetic compressors of any brand for capacities of 1/2 to 1/2 H.P. Saves money on your stocks as all other relays are eliminated. 220 V-50 cycles.

Part No 9881406

SPP-220

Universal power relay used on all window air-conditioning units from 1/2 to 10 H.P. capacity. Voltage: 110-240 V

Part No 9881402



ICG-220



SPP-220

应用工具 - Tools

铜毛细管 - Copper Capillary Tubing

纯软铜管线圈，约100英尺(30米)长。密封脱水小直径插头铜毛细管，可提供整100英尺长度的线圈。

Pure soft copper tube in coils of about 100 feet (30 m). Sealed and dehydrated small diameter plug-drawn copper capillary tubing, available in 100 foot exact length coils.

规格

Specifications

名称 Designation	Ø 英寸 内径 外径 Ø inches inside outside		Ø 毫米 内径 外径 Ø mm inside outside		每圈长度 英尺 米 Length per coil feet meter		部件号 Part No
	TC-26	0.026	0.075	0.7	1.9	100	
TC-31	0.031	0.078	0.8	2.0	100	30	9881105
TC-36	0.036	0.083	0.9	2.1	100	30	9881104
TC-42	0.042	0.089	1.0	2.2	100	30	9881103
TC-44	0.044	0.090	1.1	2.3	100	30	9881102
TC-49	0.049	0.097	1.25	2.45	100	30	9881101
TC-50	0.050	0.098	1.3	2.5	100	30	9881100
TC-55	0.055	0.102	1.4	2.6	100	30	9881099
TC-59	0.059	0.106	1.5	2.7	100	30	9881098
TC-64	0.064	0.110	1.6	2.8	100	30	9881097
TC-70	0.070	0.118	1.8	3.0	100	30	9881096
TC-75	0.075	0.122	3.1	3.1	100	30	9881095
TC-80	0.080	0.125	3.2	3.2	100	30	9881094
TC-90	0.090	0.138	3.5	3.5	100	30	9881093



10971

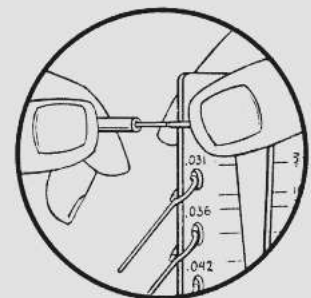
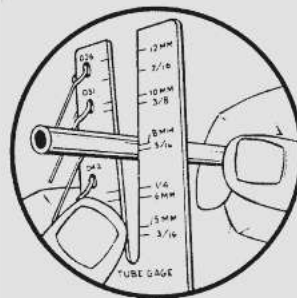

毛细管计量仪

10971

帽形计量工具，以毫米或英寸测量所有毛细管。

部件号 9881088

Capillary Tube Gauge

10971

Cap Gauge Tool to measure all capillary tubes in millimeter (mm) as well as inch sizes.

Part No 9881088



TCK-1000-V

O形环垫圈银铜焊

配备施瑞德(Schrader)阀开启器的毛细管
所有REFCO毛细管部配备O形环。在连接过程中不会造成管的扭曲,从而在更换系统中任何控制捺或在连接压力开关、计量仪、压力水控制器时避免了制冷剂的流失。

内径 1.5 毫米
外径 3.0 毫米

With O-ring-gasket Silver Brazing

Capillary tube with Schrader-valve opener
All REFCO-capillary-tubes are equipped with O-rings. A twisting of the capillary tube during the connection is excluded. To prevent loss of refrigerant when changing any controls and to connect pressure-switches, gauges, pressurized water controls etc. on your systems.

Diameter inside 1.5 mm
Diameter outside 3.0 mm



O形环

O-Ring



压器

Depressor



机制铜件

Machined Brass-Body

锻造螺母 Forged Nut



毛细管

Capillary Tube

配备2个1/4英寸SAE剖螺母配备或不配备施瑞德阀开启器

Capillary tube with 2 nuts 1/4" SAE with or without access Schrader-valve opener

名称 Designation	长度 毫米 Length in mm	连接 Connection	压器 Depressor	部件号 Part No
TCK-500-V	500	1/4" SAE=7/16" UNF	Yes/是	9881117
TCK-1000-V	1000	1/4" SAE=7/16" UNF	Yes/是	9881116
TCK-1500-V	1500	1/4" SAE=7/16" UNF	Yes/是	9881115
TCK-2000-V	2000	1/4" SAE=7/16" UNF	Yes/是	9881114
TCK-3000-V	3000	1/4" SAE=7/16" UNF	Yes/是	9881113
TCK-500	500	1/4" SAE=7/16" UNF	No/不是	9881112
TCK-1000	1000	1/4" SAE=7/16" UNF	No/不是	9881111
TCK-1500	1500	1/4" SAE=7/16" UNF	No/不是	9881110
TCK-2000	2000	1/4" SAE=7/16" UNF	No/不是	9881109
TCK-3000	3000	1/4" SAE=7/16" UNF	No/不是	9881108

附件

TCK-005/10

用于O形环松脱铜焊的调节器, 10枚
部件号 9881107

TCK-005-V/10

同上, 配阀, 10枚
部件号 9884745

Accessories

TCK-005/10

adapter for brazing with O-ring loose, 10 pcs.
Part No 9881107

TCK-005-V/10

as above. with depressor, 10 pcs.
Part No 9884745

应用工具 - Tools

聚酯胶毛细管 - Schrader-间1/4英寸SAE - Polyamide capillary tube - Schrader-Valves 1/4" SAE

聚酯胶毛细管

P-2001

聚酯胶毛细管调制套组的毛细连接螺纹可在对冷冻系统进行维修时直接便利地制作。温度范围-40至+80摄氏度。工作压力30巴成套包括:

- 1枚 坚固塑料箱特制内部设置
 - 100枚 NS4-4-1/4英寸SAE螺母
 - 100枚 M6蝶纹接套及O-形环
 - 100枚 M6上紧螺母
 - 50米 聚酯胶毛细软管
- 部件号 **9883690**

备件:

P-2001-NS4-4-1/4/100

100枚NS4-4-1/4英寸SAE螺母
部件号 **9883686**

P-2001-110/100

100M6蝶纹接套及O-形环
部件号 **9883687**

P-2001-120/100

100 M6上紧螺母
部件号 **9883688**

P-2001-504

50米聚酯胶毛细软管
部件号 **9883689**

聚股胶毛细管连接螺纹及2个1/4英寸SAE无阀螺母

名称	长度	部件号
TCP-500	500	9883691
TCP-1000	1000	9883692
TCP-1500	1500	9883693



A-31999-R



A-31999-G



A-40720

Polyamide capillary tube

P-2001

Polyamide capillary confectioning set Capillary connection lines can be made easy and directly when servicing a refrigeration unit.

Temperature range -40 - +80 °C
Working pressure 30 bar

Set consisting of:

- 1 pc sturdy plastic case with special insert
- 100 pcs. nuts NS4-4-1/4" SAE
- 100 pcs. nipples M6 with O-ring
- 100 pcs. tightening nuts M6
- 50 metres polyamide capillary hose

Part No **9883690**

Spares:

P-2001-NS4-4-1/4/100

100 pcs. nuts NS4-4-1/4" SAE
Part No **9883686**

Schrader-间1/4英寸SAE

A-31999-R/10

红色阀心及聚四氟乙烯和氯丁二烯橡胶垫圈用于各种温度下的HCFC(R12, R22, R502), 以及HCF=R134a达120摄氏度。

部件号 **9883488**

A-31999-R/100

红色阀心, 100枚
部件号 **9883854**

A-31999-G/10

仅适用HFC=R134a制冷气体的绿色阀心, 带绿色聚四氟乙烯扁平HNBR橡胶垫圈:适用于所有连接于R134a的系统温度达120摄氏度的电器。10枚

部件号 **9880864**

A-31999-G/100

绿色阀心, 100枚
部件号 **9883873**

插入阔3/8英寸SAE "特大号"

全新的设计和创造, 3/8英寸SAE插入阀零配件系列更容易插入商业型冷冻单位, 由于阀门的开口更宽大, 可节省相当可观的时间。目前可提供所有3/8英寸SAE连接和HCL6充气线3/8英寸SAE压器的威科必须工具。

A-40720/5

全套插入阀零配件包括内径3/8英寸、外径3/8和1/2英寸管的阀心和快速封帽。5枚

部件号 **9884814**

P-2001-110/100

100 pcs. nipples M6 with O-ring

Part No **9883687**

P-2001-120/100

100 pcs tightening nuts M6

Part No **9883688**

P-2001-504

50 m polyamide capillary hose

Part No **9883689**

Polyamide capillary connection line with 2 nuts 1/4" SAE without valve

Designation Length Part No

TCP-500 500 **9883691**

TCP-1000 1000 **9883692**

TCP-1500 1500 **9883693**

P-2001

Schrader-Valves 1/4" SAE

A-31999-R/10

Valve Core red with Teflon and Neopren gasket for HCFC (R 12, R22, R502) for all temperatures and for HFC = R134a up to 120 °C.

Part No **9883488**

A-31999-R/100

Valve Core red, 100 pcs.

Part No **9883854**

A-31999-G/10

Valve Core green suitable only for HFC = R134a refrigerant gas with green Teflon and flat HNBR gasket; suitable for all applications in connection with R134a systems for temperatures up to 120 °C. 10 pcs.

Part No **9880864**

A-31999-G/100

Valve Core green, 100 pcs.

Part No **9883873**

Access Valves 3/8" SAE "King-Size"

The new designed and created 3/8" SAE access fitting series grants interventions on commercial refrigeration units much more easy by saving substantial time, since the opening of the valves are much wider. Necessary tools from REFCO with all 3/8" SAE connections as well as depressors on HCL6 charging lines 3/8" SAE are available now.

A-40720/5

Access fitting complete with valvecore and quick seal cap for tubes inside 3/8"; outside 3/8" and 1/2". 5 pcs.

Part No **9884814**





适合于永久性安装于密封的机组上。

这种类型的钻阀绝对紧固并便于安装。

优点:

- 阀体以锻铜制
- 阀轴由高质钢制造, 已强化
- O-形环封闭
- 具有3毫米allen套栓, 便于安装
- 阀轴使用同样3毫米allen套栓 (Allen key) 操作
- 内置阀轴避免过深钻孔进入管内, 或在阀上开口过大连接为1/4英寸SAE
- 因而符合所有型号的充气线
- 不需要额外的调节德或工具

LT-3G/10

用于5毫米=3/16英寸管的阀, 10枚
部件号 **9883993**

LT-4G/10

用于6毫米=1/4英寸管的阀, 10枚
部件号 **9883994**



LT-4G

LT-5G/10

用于8毫米=5/16英寸管的阀, 10枚
部件号 **9883995**

LT-6G/10

用于10毫米=3/8英寸管的阀, 10枚
部件号 **9883996**

包装:

10枚装箱, 包括1枚3毫米allen套栓

LT-01/10

垫圈, 10枚
部件号 **9884871**

维修接驳阀

A-33010

接驳控制阀
1/4" SAE x 1/4" SAE
部件号 **4681636**

A-33410

接驳控制阀
1/4" SAE x 1/2" -20 UNF
部件号 **4681645**



A-33410

Suitable to be fitted permanently on to sealed units.

This type of piercing valve is absolutely tight and very easy to install.

Benefits:

- Body manufactured from forged brass
- Valve spindle made from quality steel, hardened
- O-ring sealed
- Easy to install with allen-key 3 mm
- Valve spindle to be operated with same allen-key 3 mm
- Built-in valve spindle avoids a too deep piercing into the tube or a too big opening of the valve
- Connection 1/4" SAE, therefore fits all brands of charging lines
- No additional adapter or tool required

LT-3G/10

Valve for 5 mm = 3/16" tube, 10 pcs.
Part No 9883993

LT-4G/10

Valve for 6 mm = 1/4" tube, 10 pcs.
Part No 9883994

LT-5G/10

Valve for 8 mm = 5/16" tube, 10 pcs.
Part No 9883995

LT-6G/10

Valve for 10 mm = 3/8" tube, 10 pcs.
Part No 9883996

Packing:

10 pcs. in one carton including one allen-key 3 mm.

LT-01/10

Gasket only, 10 pcs.
Part No 9884871

Access Service Valve Actuator

A-33010

access control valve
1/4" SAE x 1/4" SAE
Part No 4681636

A-33410

access control valve
1/4" SAE x 1/2" -20 UNF
Part No 4681645



LT-4G

技术数据与公司信息 - Technical Information

压力 - 供冷冻领域使用的压力单位转换表

Pressure - Conversion table for pressure units used in the field of refrigeration

市 / from	艺 / to	巴 bar	毫巴 mbar	帕斯卡 Pa	公斤帕斯卡 kPa	(平方英寸/磅) psi
1 巴 / 1 bar		1	1000	100 000	100	14,5
1 毫巴 / 1 mbar		0,001	1	100	0,1	0,0145
1 帕斯卡 / 1 Pa		0,00001	0,01	1	0,001	0,000145
1 公斤帕斯卡 / 1 kPa		0,01	10	1000	1	0,145
1 (平方英寸/磅) / 1 psi		0,069	69	6900	6,9	1
1 毛 / 1 Torr		0,00133	1,3	133,3	0,1333	0,0193

互换关系:

1毛 = 1毫米水银
1毛 = 1000毫米
1微米 = 0,00133毫巴

Further relations

1 Torr = mmHg
1 Torr = 1000 Micron
1 Micron = 0,00133 mbar

普通螺纹

开张接口

适合90度焊铜接头管和螺母SAE (UNF) 的螺纹与国际冷冻系统标准相符(根据DIN8904和ASAB 1.1.).

Common Threads

Flaring connections

Copper connection to fit 90°Flair copper tube and nut SAE (UNF) is the thread corresponding to the international standard for refrigeration according to DIN8904 and ASA B 1.1.

螺纹 Thread UNF	美国规格 US Specification SAE	外径(最大尺寸) 毫米 o.d. (max. size) mm	心直径(最小尺寸)毫米 core. dia. (max. size) mm	螺距数(每英寸) pitch number per inch	螺距毫米毫米 pitch mm
7/16 英寸 - 20 UNF	1/4 英寸 SAE	11.079	9.738	20	1.270
1/2 英寸- 20 UNF	5/16 英寸 SAE	12.667	11.328	20	1.270
5/8 英寸- 18 UNF	3/8 英寸 SAE	15.839	14.348	18	1.411
3/4 英寸- 16 UNF	1/2 英寸 SAE	19.012	17.330	16	1.588
7/8 英寸- 14 UNF	-	22.184	20.262	14	1.814
7/8 英寸- 14 UNF	5/8 英寸 SAE	22.184	20.262	14	1.814
1 英寸- 14 UNF	3/4 英寸 SAE	25.357	23.437	14	1.814
1 1/16 英寸 - 14 UNF	-	26.947	25.024	14	1.814
1 1/8 英寸- 12 UNF	-	28.529	26.284	12	2.117
1 1/4 英寸- 12 UNF	7/8 英寸 SAE	31.704	29.459	12	2.117
1 3/8 英寸- 12 UNF	-	34.877	32.634	12	2.117
1 1/2 英寸- 12 UNF	1 英寸 SAE	38.052	35.809	12	2.117

温度转换表

°C in °F = °C 乘 1.8 加 32 等于 °F
°F in °F = (°F 减 32): 1.8 等于 °C

Temperature conversion table

°C in °F = °C x 1.8 + 32 = °F
°F in °C = (°F - 32): 1.8 = °C

°C/摄氏度	°F/华氏度	°C/摄氏度	°F/华氏度
100	212	212	100
95	203	200	93
90	194	190	88
85	185	180	82
80	176	170	77
75	167	160	71
70	158	150	66
65	149	140	60
60	140	130	54
55	131	120	49
50	122	110	43
45	113	100	38
40	104	90	32
35	95	80	27
30	86	70	21
25	77	60	16
20	68	50	10
15	59	40	4
10	50	30	0
4	39	20	-7
0	32	10	-12
-10	14	0	-12
-20	-4	-10	-23
-30	-22	-20	-29
-40	-40	-30	-34
-50	-58	-40	-40
-60	-76	-50	-46
		-60	-51
		-112	-80
-273	-460	-460	-273

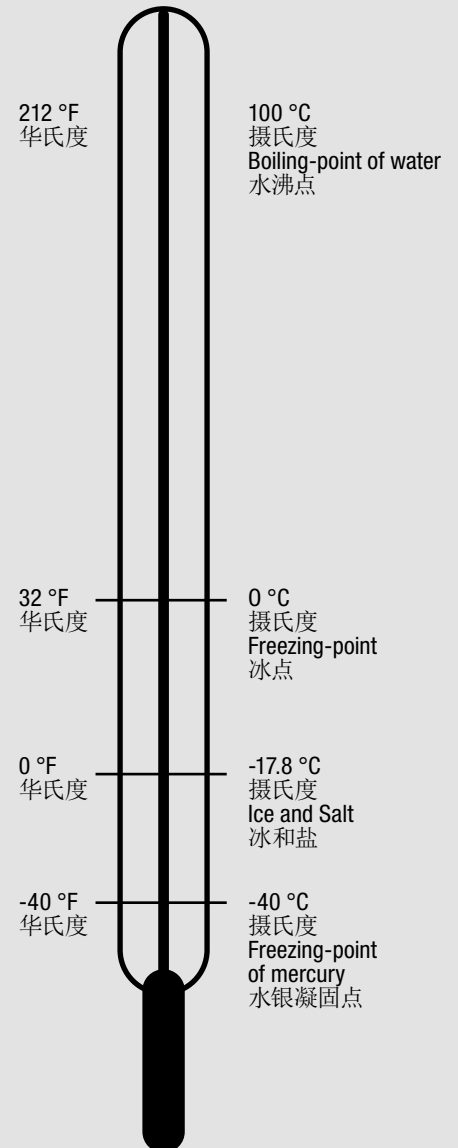

版权所有©

任何文字, 插图和版本27所发布的任何信息都受到威科制造有限公司版权所有。未经威科的书面授权, 不允许版本27的某部分或整体的转载。威科名义下的交易在相应国家已取得注册商标。请你使用来自自己授权的威科经销商的正版威科产品。除非你使用原厂配件, 否则我们将不承担任何法律法规范围内的责任。负责您的威科的合作伙伴将很乐意提供建议。

COPYRIGHT ©

Any texts, illustrations and any other information published here are subject to the copyright of REFCO Manufacturing Ltd. A reproduction or representation in its entirety of parts of it is not allowed without written authorisation of REFCO. Trading under the name REFCO is a registered trademark in the respective countries. Please use only original REFCO spare parts of your authorised REFCO dealer. We shall not assume responsibility in the scope of the legal regulations unless you use original parts. Your REFCO partner in charge will be pleased to provide advice.

生产 - Production





物流 - Logistic





展会全球 - Trade Shows Worldwide



Germany, Chillventa



Italy, Mostra Convegno



UK, RAC



China, China Refrigeration



Mexico, AHR Expo



USA, ASHRAE Expo

总部瑞士 - Head Office Switzerland



制冷服务产品和组件

REFCO是一家成立于1972年的瑞士公司，并从一家小企业成功发展成为全球知名的制冷服务产品和组件的供应商。生产高品质的产品是我们至始至终一贯的目标。吸取客户的特殊需求，结合我们的技术，生产出持久耐用和安全领域里独一无二的产品是我们发展中的重中之重。

Manfred P. Ulrich
CEO

Refrigeration Service Products and Components

The Swiss enterprise REFCO was founded in 1972 and has successfully developed from a small company to a world wide renown supplier of Refrigeration Service Products and Components. Right from the beginning our aim has been to manufacture products of the highest quality and this is still in force today. A key event in our progress has been to absorb our customers' specific requirements and, with our technology, provide a product range unequalled for durability and reliability.

Manfred P. Ulrich
CEO

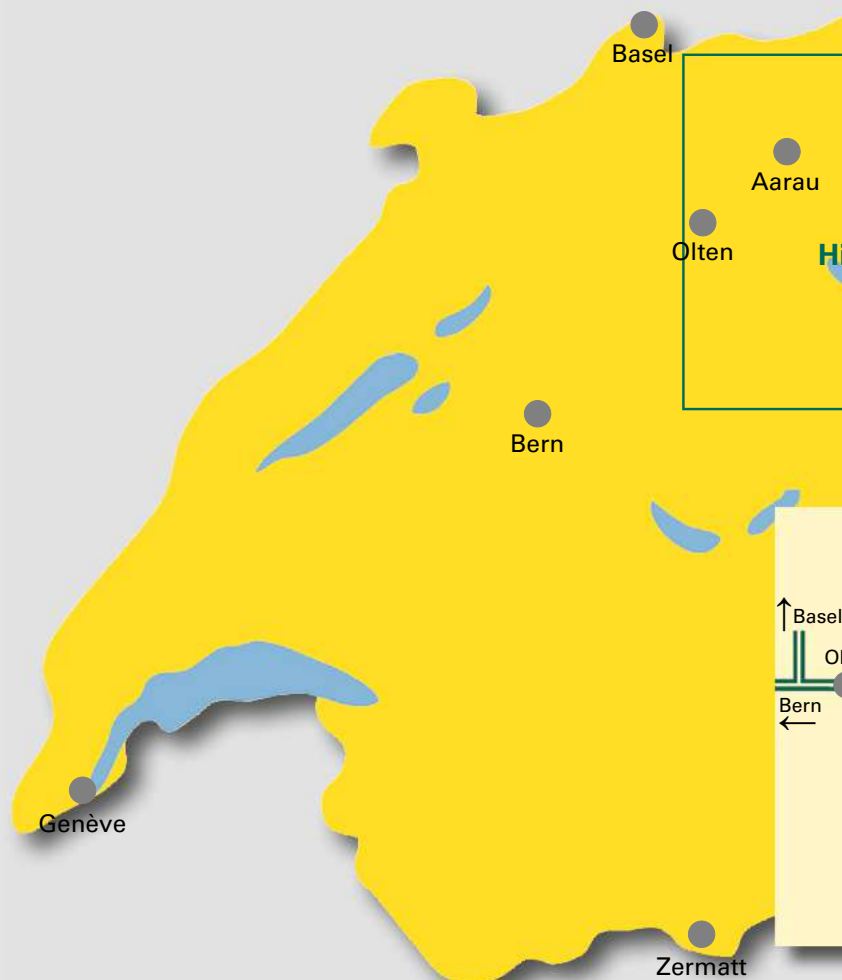

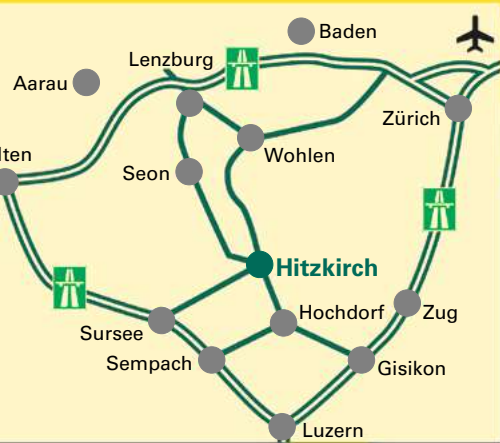

威科制造商
REFCO Manufacturing Ltd.
Industriestrasse 11
6285 Hitzkirch - Switzerland

电话 41 41 919 72 82
传真 41 41 919 72 83
电邮 info@refco.ch
网址 www.refco.ch

**HVAC/R
Service Products**

